

MAINTENANCE AND OPERATION
INSTRUCTION MANUAL

SmartGen Mini

Compact RDS/RBDS Encoder
with LAN & USB Connectivity



UECP Compatible



Contents

Introduction	6
Typographic conventions	7
General Information	8
Product Features	9
<i>Technical Specifications</i>	10
<i>Block Diagram</i>	12
<i>Front Panel</i>	13
<i>Rear Panel</i>	14
Safety Warning	15
Operating Recommendations	16
Unpacking and inspection	17
Mounting	17
<i>Rack Requirements IU</i>	17
<i>Rack Requirements Compact Units</i>	17
<i>Stand-Alone Devices</i>	17
Getting Started	18
<i>Connection</i>	18
<i>Network Settings</i>	19
<i>Network Discovery</i>	19
<i>Network Security Recommendations</i>	20
Addressing The SmartGen Mini	21
Selection of Operating Modes	22
<i>Sidechain Mode</i>	22
<i>Loop-Through Mode</i>	22
Connecting The SmartGen Mini	23
<i>Important Connection Considerations!</i>	23
<i>Sidechain Mode (preferred)</i>	24
<i>Loop-Through Mode</i>	25
Data Interconnection	26
<i>USB Port</i>	26
<i>LAN Port</i>	26
<i>Computer or Terminal Requirements</i>	26
Subcarrier Injection Level	27
<i>Setting Subcarrier Amplitude</i>	27
<i>Subcarrier Phase</i>	28
Programming Options	29
<i>Advanced Programming for Station Automation</i>	29
<i>Simplified Windows® Data-Entry Software</i>	29
Terminal Configuration	30
<i>TCP/IP Port Configuration</i>	31
<i>Power-Up</i>	32
<i>Echo</i>	33
ASCII Programming Syntax	34
<i>How to Type</i>	34
<i>Using ALL-CAPS</i>	34
<i>Correcting Mistakes</i>	34
<i>Validity Symbols</i>	35

Encoder Housekeeping Commands	36
<i>Register Interrogation</i>	<i>36</i>
<i>Encoder Initialization</i>	<i>36</i>
<i>Encoder Reset</i>	<i>36</i>
<i>Firmware Version</i>	<i>36</i>
<i>Network Settings.....</i>	<i>36</i>
Listing of Encoder Commands and Prompts	37
Factory Defaults	40
<i>Network settings</i>	<i>40</i>
<i>General Settings</i>	<i>40</i>
<i>Basic RDS Settings.....</i>	<i>41</i>
<i>UECP Settings.....</i>	<i>41</i>
WEB Configuration	42
<i>Basic RDS.....</i>	<i>43</i>
<i>AF List / Group Sequence</i>	<i>45</i>
<i>How to add a new AF Method A.....</i>	<i>46</i>
<i>How to add a new AF Method B</i>	<i>47</i>
<i>Add Group Sequence</i>	<i>48</i>
<i>Settings</i>	<i>49</i>
<i>Firmware Update</i>	<i>49</i>
<i>Monitor.....</i>	<i>50</i>

APPENDIX A	51
<i>RDS: Europe vs America</i>	51
<i>The RDS System</i>	51
APPENDIX B.1	52
<i>PTY Code Description Used in RBDS Mode – North America</i>	52
APPENDIX B.2	53
<i>PTY Code Description Used in RDS Mode – Europe, Asia</i>	53
APPENDIX C	54
<i>RDS Applications Supported</i>	54
<i>AF</i>	54
<i>CT</i>	54
<i>DI</i>	54
<i>ECC</i>	54
<i>EON</i>	55
<i>EWS</i>	55
<i>FFG</i>	55
<i>IH</i>	55
<i>M/S</i>	55
<i>ODA</i>	55
<i>PI</i>	55
<i>PIN</i>	56
<i>PS</i>	56
<i>PTY</i>	56
<i>PTYN</i>	56
<i>RT</i>	56
<i>RT+</i>	57
<i>TA</i>	57
<i>TDC</i>	57
<i>TMC</i>	57
<i>TP</i>	57
Product Registration Card	58
WARRANTY TERMS AND CONDITIONS	59

THIS PAGE
IS INTENTIONALLY
LEFT BLANK

Introduction

DEVA Broadcast Ltd. is an international communications and high-technology manufacturing organization, its corporate headquarters and facility located in Burgas, Bulgaria. The company serves the broadcast and corporate markets worldwide – from consumers and small businesses to the largest global organizations. It is dedicated to the research, design, development and provision of advanced products, systems and services. DEVA Broadcast launched its own brand back in 1997 and has nowadays evolved to become known as a market leader and internationally reputed manufacturer of user-friendly, cost-effective and innovative broadcast products.

Creativity and innovation are deeply woven into DEVA Broadcast corporate culture. Through successful engineering, marketing and management our team of dedicated professionals creates future-oriented solutions to improve customers' performance. You may rely that all issues communicated to our crew would be addressed accordingly. We pride ourselves on our pre and post-sales support and purchase services, which along with the outstanding quality of our radio gear have won us due respect and the market authority position.

DEVA Broadcast best-of-breed solutions have become the best sellers for our partners. The strategic partnerships which have been formed with industry leaders during all these years that we have been operating on the broadcasting market, have proved us a reliable business partner and a valuable asset, as our dealers worldwide would confirm. In constant pursuit of precision and long-term satisfaction, DEVA Broadcast enhances the reputation of our partners and clients alike. Furthermore, we have already a proven merit as a credible partner provider.

Our portfolio offers complete line of high quality and competitive products for FM and Digital Radio, Radio Networks, Telecommunication Operators and regulation authorities. For almost two decades of intensive software and hardware development, we have achieved a unique price-performance and endurance of our product lines. Our company's multitude of equipment and services is in line with the latest technologies and key trends. The most recognizable characteristics attributed to DEVA Broadcast products are their clear-cut, streamlined design, easiness of use and cost-effectiveness: simplicity of forms but multiplicity of functions.

For us there is no stage when we deem that we have reached the most satisfactory level in our work. Our engineers are in constant pursuit of new ideas and technologies to be captured in DEVA Broadcast solutions. Simultaneously, a strict control is being exercised at each step of any new development. Experience and hard work are our fundament but the continuous improving process is what we never leave aside. DEVA Broadcast participates on a regular basis in all landmark broadcasting events, not only to promote its products, but to exchange valuable know-how and experience. We are also engaged in international large-scale projects involving radio and audio solutions which makes us even more competitive on the global market.

All DEVA Broadcast products are developed and produced in accordance with the latest ISO 9001 quality control standards.

Typographic conventions

The following table describes important conventions used in the manual.

Convention and Style	Description	Examples
<i>Menu > Sub Menu > Menu Command</i>	A menu item(s) and menu command that you need to click in sequence	Click <i>Settings > General</i>
[Button]	Interface Interactive buttons	Press [OK] to save the changes
NOTE	Important notes and recommendations	NOTE: The notification will appear only once
<u>“Reference Name” on Page XXX</u>	References and links	refer to <u>“New Connection”</u> (see <u>“Monitoring” on page 56</u>)
Example	Used when example text is cited	Example for E-mail Notification: Date: 04 Nov 2013, 07:31:11

General Information

Compact, Robust, Reliable and Smart – This is just a small part of all the benefits of our Second Generation RDS/RBDS Encoder SmartGen Mini. The interactive function RT+ for song tagging is fully supported without a compromise. Based on the latest RDS technology, the SmartGen Mini is fully digital design for 24/7/365 operation. The SmartGen Mini is the most cost effective solution for sending TMC and EWS Services. It supports both of European CENELEC and United States NRSC standards and is fully compatible with the latest UECP EBU SPB490 Version 7.05

SmartGen Mini gives dynamic, on-the-fly programming access with its built-in USB, TCP/IP, UDP/IP interfaces. This connectivity permits full integration of RDS/RBDS transmissions with the station's other networked functions, including message streams for digital radio and Webcasting. The SmartGen Mini encoder provides a full loopthrough interface for connection to your existing broadcast chain. The SmartGen Mini can 'parse' scrolling text, automatically breaking phrases into word groups.

The SmartGen Mini has all the RDS features you would ever need at an incredible price.

Product Features

- Supports European CENELEC and United States NRSC standards
- Attractive price and very good price-performance ratio
- Supports RT+ for songs and content tagging
- PS & Radio Text Scrolling Options
- Supports TMC (Traffic Message Channel)
- Compatible with EWS (Emergency Warning System)
- Embedded WEB server for interactive supervision
- Fully Digital Synthesis of RDS signal
- Fully compatible with UECP EBU SPB490 Version 7.05
- MPX Loopthrough & Sidechain Modes
- Internal or external Pilot / MPX synchronisation
- Very Intuitive UECP Configuration Software
- Remote RDS viewer to visualize broadcasted data
- Proved and reliable hardware for 24/7/365 operating
- Easy Installation and Setup
- LAN & USB Programming Interfaces
- Remote configuration via ASCII or UECP through LAN or USB
- Interfaces with all popular radio automation systems
- Built-in dedicated 19kHz source for internal sync
- Built-in failsafe bypass relay
- Includes the TA function for traffic message priority override
- Works with any FM exciter and stereo generator
- SNTP for automatic synchronization of the built-in clock
- Internal data diagnostics and transmission safeguards
- Real time clock Schedules for Scrolling Text and text lists
- Compact and Robust Aluminum Case for high RF immunity

TECHNICAL SPECIFICATIONS

TECHNICAL SPECIFICATIONS	
Chassis Dimensions	4.72" x 4.06" x 1.2", 120 x 103 x 31mm
Shipping Weight	1kg
Power Supply	External, 12V / 0.5A
Pilot/MPX Input	Yes
MPX/RDS Output	0 to 4095 mV
Communication Port	USB, LAN
Synchronization	External (Pilot or MPX); Internal; Auto
Synchronization Monitoring	Yes
RDS Level adjustment	Digitally controlled
Phase adjustment	Yes, 0 ÷ 359.9°
Command to activate the RDS SCA	Yes
Side Chain Mode, Loop through mode, Bypass feature	Yes
RDS Subcarrier	100% Digitally Generated Shape
Pilot synchronization	Input Level: -50dBu to +12dBu Frequency: 19kHz, ±3Hz
EN50067 compliant	Yes
Accurate Clock Time (CT) Sync with Internet Connection	Yes
Remote TA actuation for Traffic Announcements	Yes
Firmware can be upgraded in the field	Yes
Operating Temperature	0°C ÷ 55°C
RDS FEATURES	
Group supported	All
Group Sequence	Configurable
PS	4 DSN x 4 PSN
PI	4 DSN x 4 PSN
PTY	RDS/RBDS
AF Method A	25
AF Method B	up to 50
RT	Yes, 5 messages
RT rate adjustment	Group Sequence
RT+ for songs and content tagging	Yes
TP	Yes
TA Control	Command, Software
PTYN	Yes
EON	4 PSN
CT	Yes
TMC, EWS, IH, TDC	Yes
Free Format Groups (FFG)	Yes
Open Data Application (ODA)	Yes
64-character Dynamic PS shown on all RDS/RBDS Radios	Yes

Auto “parses” long messages for best text display	Yes
Scrolling by character	from 1 up to 8
Scrolling by word, Auto centering, Truncate long words	Yes
COMMUNICATION	
Communication Interfaces	USB, LAN
Connection with Automation Software	Yes
Network Connectivity	2 TCP ports, 2 UDP ports
Scheduler	Yes
Configuration	Embedded Web Server SmartGen Manager
Password Protection	Yes
ASCII Protocol	Yes
UDP, TCP, HTTP, SNTP	Yes
UECP Protocol	Fully compliant with EBU SPB490 Ver.7.05
PI <=> CALL Calculator	Yes
Remote Display	Yes
Supplied with Intuitive Software	Yes
Comes with 2-years Limited Warranty	Yes
Accepts both ASCII and UECP Command Sets	Yes

BLOCK DIAGRAM

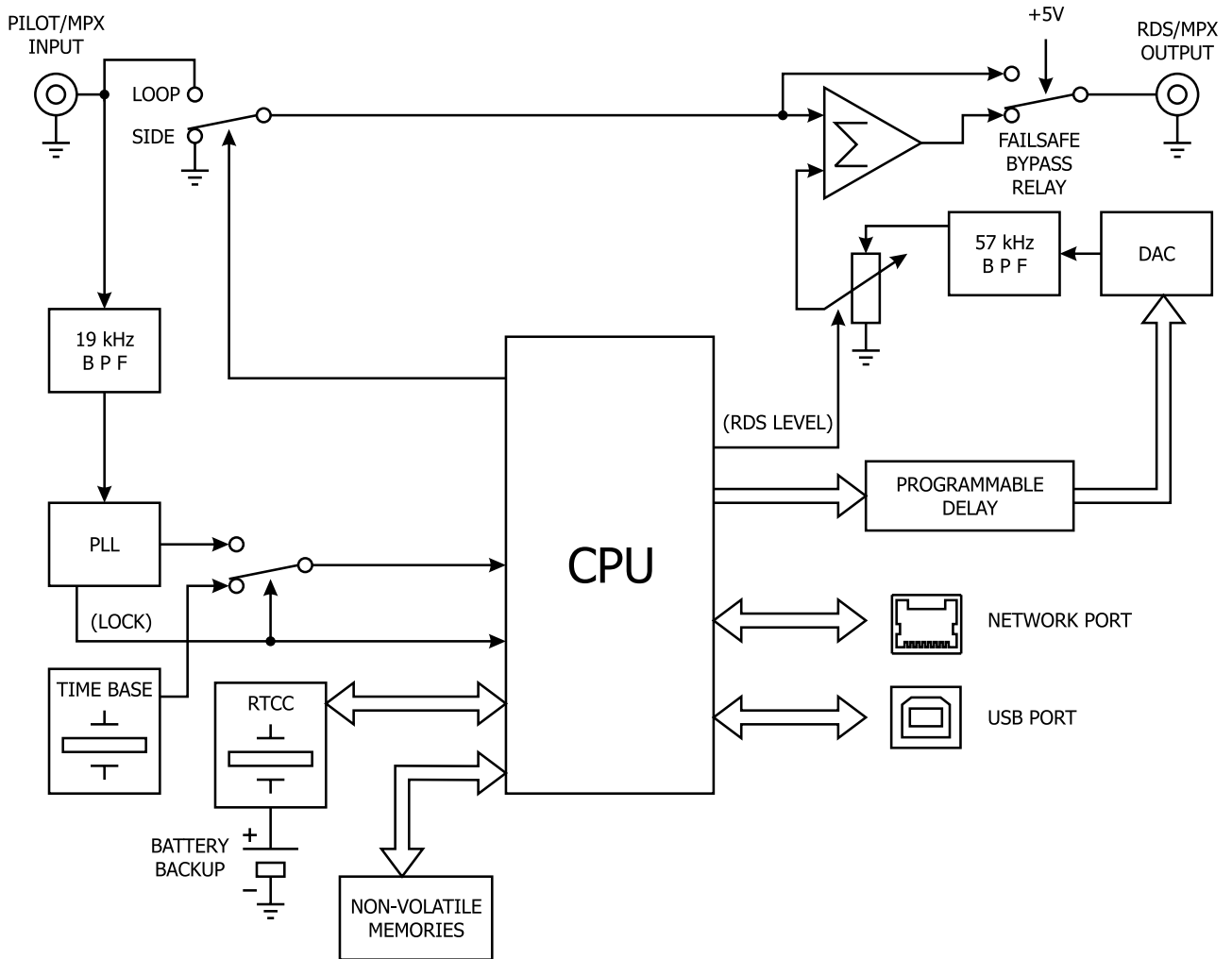

FRONT PANEL

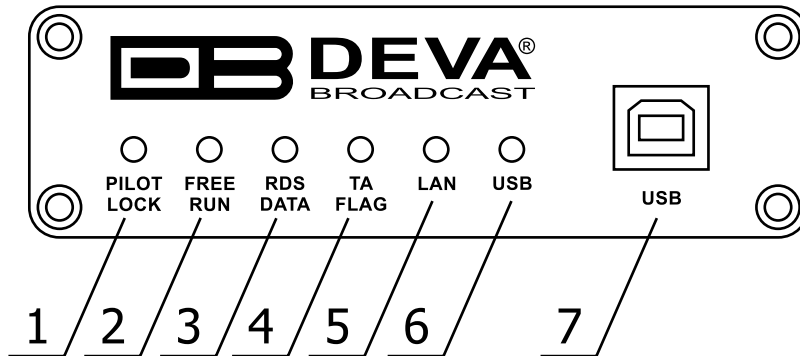

1. PILOT LOCK - This LED lights when the encoder has locked to the 19kHz stereo pilot signal from the stereo generator, either in the sidechain or the loop-through mode of encoder operation.

2. FREE RUN - Will be lit when no 19kHz pilot is present at the PILOT OR MPX INPUT, and the synchronization source is set to “Auto”, the encoder defaults to a crystal-controlled internal timebase. This enables RDS transmissions with monaural programming. When synchronization source is set to “Internal”, the FREE RUN led blinks every second.

3. RDS DATA - This LED flashes dimly as RDS data is being transmitted, serving as an indication that the encoder is operating normally. When synchronization source is set to “External”, and no 19kHz pilot is present at the PILOT OR MPX INPUT, the LED flashes with period of four blinks per second to indicate the absence of RDS signal at the encoder’s output. If the RDS output is set to OFF. The LED will not be lit.

4. TA FLAG - This LED flashes whenever the TA flag is raised. **REMEMBER:** the TA flag is only temporary. It must be turned off as soon as the announcement ends.

5. LAN - Network Availability LED indicator.

6. USB - This LED lights when the USB port is addressed.

7. USB Connector - B-Type, for interconnection with PC

REAR PANEL

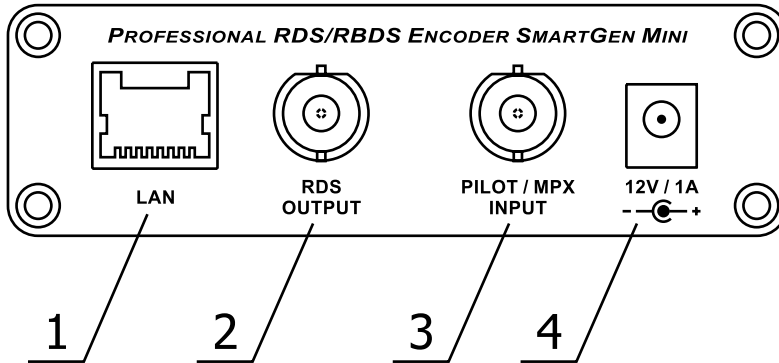

1. LAN - RJ-45 TBASE10 connector for TCP & UDP connections;
2. RDS/MPX OUTPUT - BNC Connector for RDS/MPX output signal
3. RDS/MPX INPUT - BNC Connector for RDS/MPX input signal
4. POWER SUPPLY - 12V DC/ 1A, Power Jack 1/4" (6,3 mm)

Safety Warning

ALWAYS OBSERVE THE SAFETY PRECAUTIONS.

Careful observance of the safety precautions will help prevent physical injury, damage of the equipment, and extend the equipment life.

- The servicing of electronic equipment should be performed only by qualified personnel;
- Before removing the covers the unit must be switched off and the mains cable unplugged;
- When the equipment is open, the power supply capacitors should be discharged using a suitable resistor;
- Never touch the wires or the electrical circuits;
- Use insulated tools only;
- Never touch the metal semiconductor. They might carry high voltages;
- For removing and installing electronic components, follow the recommendations for handling MOS components.
- Do not remove the factory sticker from the equipment. It contains information as regards the name, serial number and MAC address of the device.
- To join the equipment to the mains supply, use the power cord purchased with the equipment.

Operating Recommendations

To ensure normal operation of the DEVA unit, we recommend following the instructions listed below.

- Install the unit in places with good air conditioning. The unit is designed to operate within the ambient temperature range of 10 to 50°C. The equipment rack should be ventilated in order for the device to keep its internal temperature below the maximum ambient temperatures;
- We do not recommend installation in rooms with high humidity, dusty places or other aggressive conditions;
- Although the device is intended to be installed closed to exciters or transmitters, we do recommend the device to be located away from abnormally high RF fields.
- Use only checked power supply cables. We strongly recommend the usage of shielded cables;
- Connect the DEVA unit to reliable power supply sources only. In case of unstable power supply, please use Uninterruptible Power Supply (UPS);
- Use the device only with its top cover on to avoid electromagnetic anomalies. Otherwise, this may cause problems with the normal functionality of the unit;
- To ensure normal remote operation of the unit, make sure to connect the device to a good quality Internet connection;
- For the normal operation of your DEVA device, check if the network settings past through all the required data traffic.

Unpacking and inspection

Upon receipt, the equipment should be inspected for possible shipping damages. If such are found or suspected, notify the carrier at once and contact DEVA Broadcast Ltd. The original shipping carton box and packing materials should be kept for possible reuse, in case of return for Warranty repair, for example. Shipping damages as a result of improper packing for return may invalidate the Warranty!

The packing material (plastic bags, polystyrene, nails, etc.) must never be left within reach of children, as these items are potential sources of danger.

IT IS VERY IMPORTANT that the [“Product Registration Card”](#) included in the Manual be completed accurately and returned. This will assure coverage of the terms of the Warranty and it will provide a means of trace in case of lost or stolen equipment. In addition, the user will automatically receive SERVICE OR MODIFICATION INSTRUCTIONS from DEVA Broadcast Ltd.

Mounting

RACK REQUIREMENTS 1U

The unit mounts in a standard 19-inch equipment rack and requires only 1 $\frac{3}{4}$ inches (1U) of vertical rack space. In order the painted finish around the mounting holes to be protected, the use of plastic washers is recommended.

RACK REQUIREMENTS COMPACT UNITS

Our customized 1U 19-inch rack accessory provides a professional mounting option for up to three compact size DEVA units. It is made of milled aluminum and finished in black powder coat. Two extra blanking panels and set of mounting screws are provided with each rack bracket kit.

STAND-ALONE DEVICES

DEVA's stand-alone units (Radio Explorer series, BandScanner series, DVB Explorer) do not require additional tools or installation brackets.

Getting Started

In order for the normal operation of the SmartGen Mini to be guaranteed, you will need fulfill the following conditions:

1. Standard Ethernet 10/100M connection;
2. Correctly assigned Network configuration and device settings.

To make sure that all the conditions are fulfilled please, follow the instructions below.

CONNECTION

1. Install the unit on its operation place;
2. Using the provided power cable, connect the unit to the power supply network;
3. Connect the antenna cable to the RF antenna input connector located on the rear panel of the device;
4. Connect the SmartGen Mini to the TCP/IP network using direct network cable;
5. **IF GSM OPTION IS SUPPORTED** - Using the connection cable provided, connect the optional GSM modem. In order for better GSM network coverage to be achieved, please select proper place for the GSM antenna.

NOTE: The GSM antenna must be installed far enough from the monitoring devices. The GSM modem radiates RF signal that may cause spurious emissions that will may interfere with the accuracy of the measurements.

NETWORK SETTINGS

After connecting the network cable the Led ‘LAN’ located on the rear panel must be ON or flashing. The next and most important step for configuration is the adjustment procedure of the Network Communication. The settings shown below are Default Network Settings:

DHCP	Enabled
IP	Assigned by DHCP
Mask	Assigned by DHCP
Gateway	Assigned by DHCP
DNS	Assigned by DHCP
HTTP Port	80

NETWORK DISCOVERY

This is a network setting that defines whether your computer can see (find) other computers and devices on the network and whether other computers on the network can see your computer. By default, Windows Firewall blocks network discovery but you can enable it.

1. Open Advanced sharing settings by clicking the Start button, and then on “Control Panel”. In the search box, type “network”, click “Network and Sharing Center”, and then, in the left pane click “Change advanced sharing settings”;
2. Select your current network profile;
3. Click “Turn on network discovery”, and then click save changes.

NOTE: If you’re prompted for an administrator password or confirmation, type the password, provide confirmation or contact your system administrator.

If you have already enabled this function on your computer SmartGen Mini will be automatically added to the Device list section. The device will be ready for usage and no additional adjustments will be required except user name and password.

NOTE: If the port is different than the default one (80), it is necessary to specify it, for example:
`http://192.168.1.2:9000`

ATTENTION: Depending on Internet Protocol Settings, the assigned IP address may not be visible outside your local network, thus the device may be accessed only within that network. Consult with your network administrator for the appropriate IP settings.

NETWORK SECURITY RECOMMENDATIONS

1. It is not recommended the SmartGen Mini to be directly connected to the Internet. This may lead to unregulated access and/or problematic operation of the device. To ensure secure connection, we recommend the device to be installed behind a router with an active firewall.
2. If remote access to the device is needed, we recommend using VPN to the router or the port of the relevant service (WEB, SNMP, Application, etc.) to be properly NAT forwarded.
3. If NAT forward is used, it is highly recommended random ports of your choice to be used. Not the standard ones (80 for WEB, 161 for SNMP, etc.).
4. Using DMZ connection is not recommended.
5. Make sure to change the standard access credentials (usernames and passwords, SNMP communities).

For detailed information as regards the recommendations listed above or need of further instructions, please contact your network administrator.

Addressing The SmartGen Mini

Many applications, such as Radio Paging, navigational assistance, roadside message billboards, song titles, stock market updates, etc. all require continuous, on-line access to the RDS encoder by one or more service providers. Some of these applications may promise additional revenue to the station. The SmartGen Mini offers these capabilities and may be addressed by simple ASCII commands, either from station automation or directly by a connected computer.

Particularly in Europe, RDS encoders may be linked with one another for network support applications. The UECP, or Universal Encoder Communication Protocol was developed by CENELEC to support this form of operation, but over the years has seen decreased usage in favor of TCP/IP addressability or direct connection with station automation. The SmartGen Mini fully supports the UECP.

Selection of Operating Modes

SIDCHAIN MODE

Configured for sidechain operation, the rear-panel PILOT OR MPX INPUT connector simply bridges (monitors) the output of the stereo generator to derive timing information from the 19kHz stereo pilot. Alternatively, a TTL-level 19kHz sync squarewave may be applied to this input. We do not recommend this, however, as the phase relationship between the synchronizing squarewave and the 19kHz pilot component in the composite, multiplex output of the stereo generator may not be assured.

In sidechain operation the RDS OR MPX OUTPUT will contain only the RDS subcarrier, the composite/MPX signal is *not* routed through the SmartGen Mini. This operating mode best preserves multiplex signal integrity and assures uninterrupted program transmission in the event of a catastrophic encoder failure (very doubtful). As delivered, the SmartGen Mini is configured for sidechain operation.

LOOP-THROUGH MODE

When the SmartGen Mini is configured for loop-through operation, the RDS subcarrier is internally combined with the composite/MPX signal. This means that the RDS OR MPX OUTPUT *will include* the composite/MPX program signal (at unity gain) with the RDS subcarrier added. Also, in the loop-through mode the internal bypass relay will pass-through the multiplex signal in the event of an encoder power failure.

Connecting The SmartGen Mini

IMPORTANT CONNECTION CONSIDERATIONS!

The SmartGen Mini encoder must be properly configured for the desired operating mode: sidechain or loop-through before it is installed in the signal path. Use SmartGen Encoders Manager to confirm that the encoder is properly configured before connecting the SmartGen Mini to other air-chain equipment.

Also, it is important that the operating software be installed on the PC before it is connected to the encoder for programming the 'static' message registers and operating defaults. In addition, we heartily recommend testing the encoder with its controlling interface (computer, terminal, automation, etc.) before it is placed in the air chain. This will ensure that 2-way communication with the encoder can be established and that the encoder is properly initialized.

SIDCHAIN MODE (PREFERRED)

Attach a BNC 'T' adapter to the composite/MPX output of the stereo generator as shown in Figure below. Connect one side of the 'T' directly to a wideband (composite/MPX) input of the FM exciter and the other side to the PILOT OR MPX INPUT of the SmartGen Mini. (This is only a bridging 'sync' connection when the circuit board has been jumpered for sidechain operation and does not affect the composite/MPX signal.)

If the stereo generator has a dedicated 19kHz TTL-level output designated for RDS encoder sync, you may connect this to the encoder PILOT OR MPX INPUT. We do not recommend this, as a dedicated 19kHz sync output may not have the proper phase relationship with the stereo pilot.

Cable the RDS OR MPX OUTPUT of the encoder to a second wideband (subcarrier) input of the FM exciter.

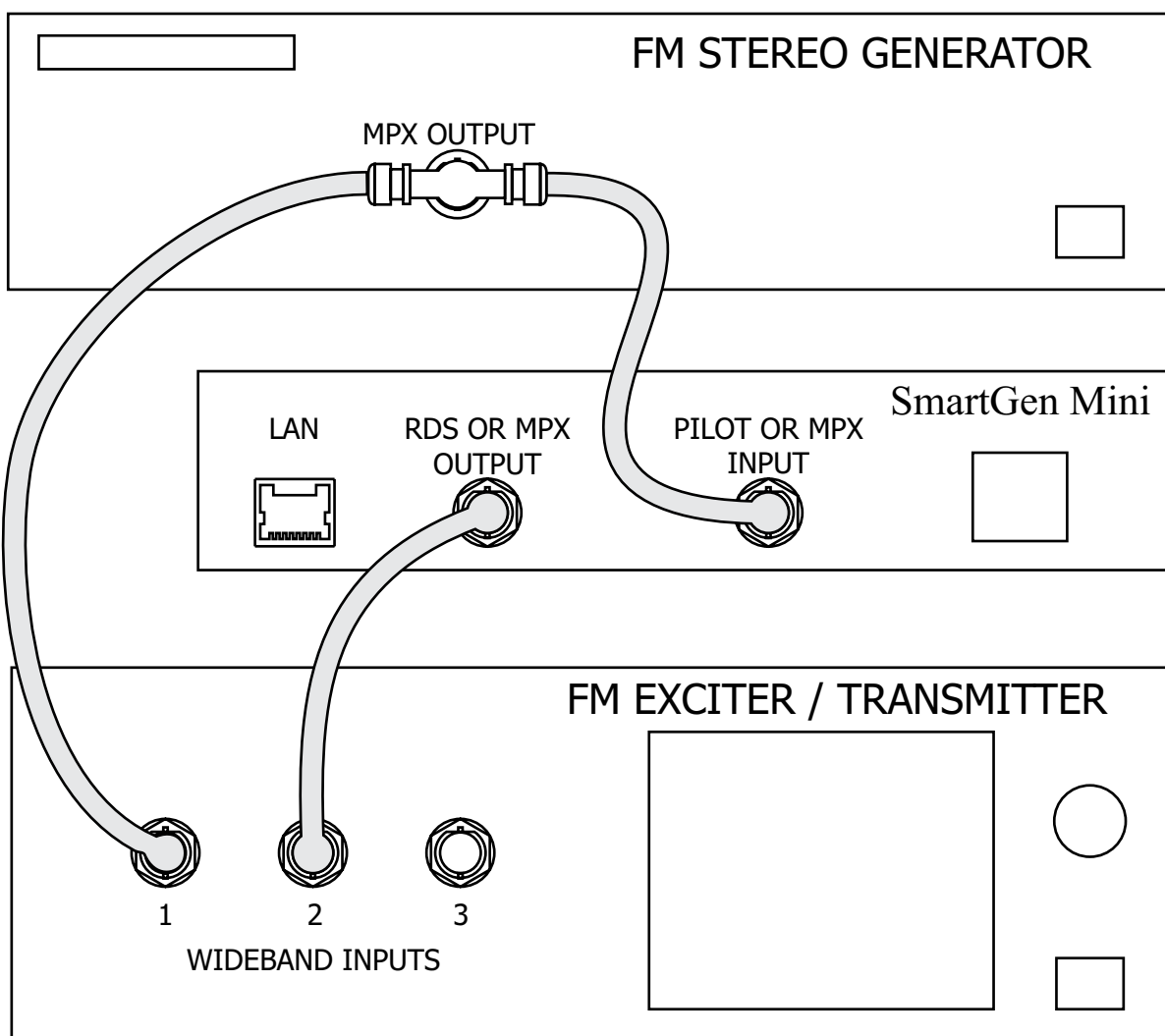

“Sidechain” Encoder Connection

LOOP-THROUGH MODE

In the loop-through mode, the output of the stereo generator is cabled directly to the PILOT OR MPX INPUT of the SmartGen Mini as shown in Figure below. Connect the RDS OR MPX OUTPUT of the encoder to a composite/MPX wideband input of the FM exciter. When configured for loop-through operation, the composite/MPX signal *passes through* the encoder with unity gain, and with the RDS subcarrier added.

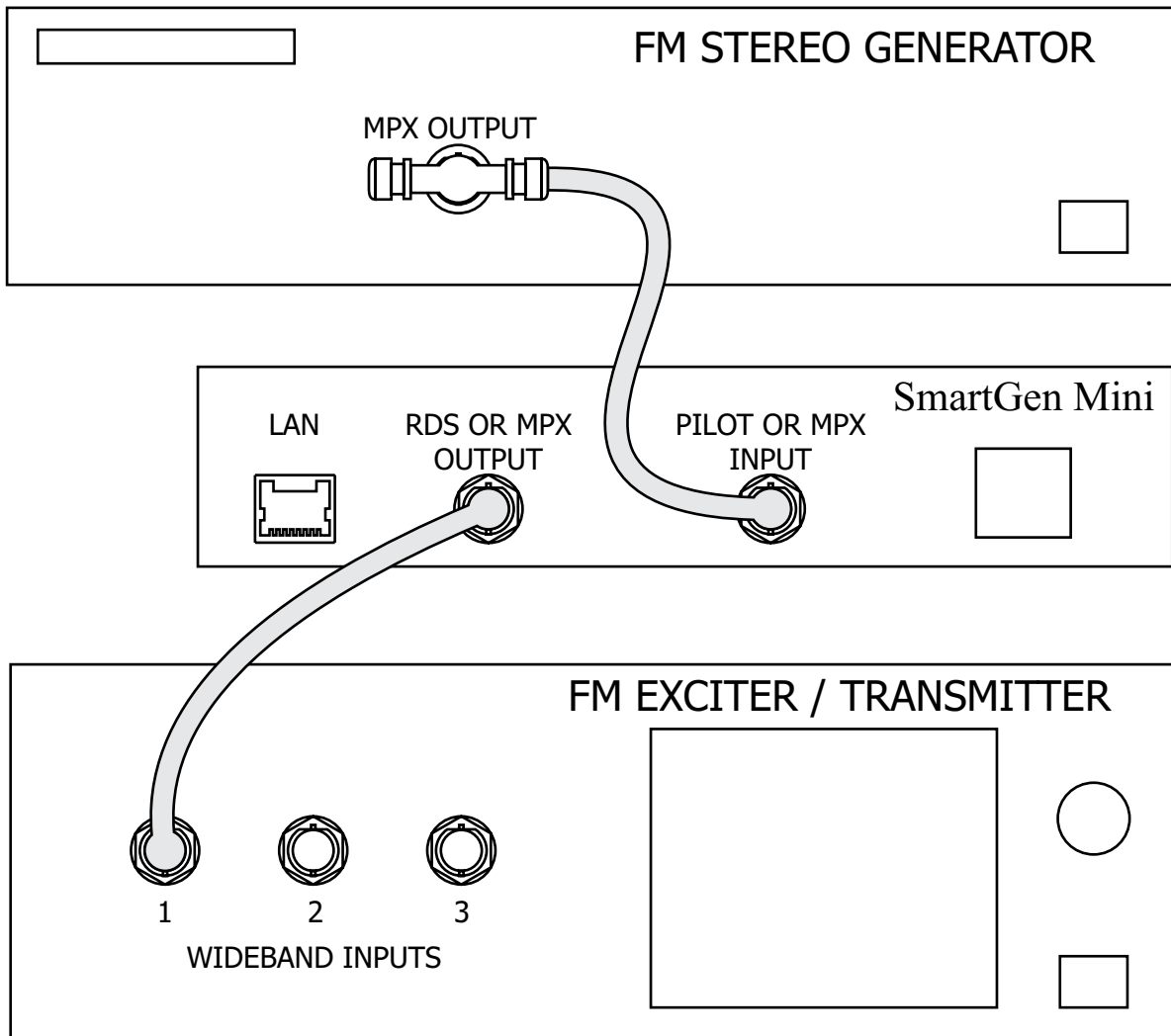

Loop-Through Encoder Connection

Data Interconnection

USB PORT

Front-panel USB port, convenient for setting service flags and entering static RDS data

LAN PORT

Rear-panel LAN port, preferred for remote monitoring. Also applicable for servicing and station automation equipment for dynamic messaging such as song titles, weather info, etc.

NOTE: For USB or LAN interfaces with a PC for local/remote programming of the ‘static’ data registers, software must be installed on the computer *before* it is connected to the encoder. Refer to software installation instructions beginning in section [“Programming Options” on page 29](#).

ASCII Communication syntax is explained in section [“ASCII Programming Syntax” on page 34](#).

COMPUTER OR TERMINAL REQUIREMENTS

For fast and easy encoder programming via the serial USB or LAN port, Windows®-based RDS Data-Entry Software routines can be downloaded from www.devabroadcast.com. Alternatively, the encoder may be addressed with any computer running a ‘terminal emulation’ program (e.g.: HyperTerminal, normally supplied with Microsoft Windows®).

Static PS and other IDs, flags, the Alternative Frequency list and operating mode options are uploaded into non-volatile encoder memory from a PC, either with USB or TCP/IP connections. If Dynamic PS or RadioText messaging is not used, a slogan, phone number or advertising messages can also be entered manually into the 64-character Dynamic PS and RadioText fields. These will be displayed on the radio faceplate as a repetitive scrolling-PS or static RadioText messages. Keep in mind that RadioText and Dynamic PS are separate functions, both of which are simultaneously available with the SmartGen Mini.

Once static data has been uploaded, the encoder may be disconnected from the computer, relocated to another operating point, or reconnected to an alternative data source for dynamic messaging. This may be a hard-disk-based station automation system that provides song title and artist, plus ads or station promos. The automation system must be configured to the encoder’s communication port and programmed to deliver dynamic data in proper syntax as explained by the instructions in section [“ASCII Programming Syntax” on page 34](#).

Subcarrier Injection Level

In the *sidechain* operation mode, the RDS subcarrier is the only signal that appears at the rear-panel RDS OR MPX OUTPUT connector. Because some exciters require a high signal level at auxiliary wideband (SCA) inputs, the RDS signal has been made adjustable to any value between zero and 4 volts, peak-to-peak.

In *loop-through* operation mode, the composite/MPX program signal that is fed to the PILOT OR MPX INPUT appears with unity gain at the RDS OR MPX OUTPUT. A typical peak-to-peak level of the Composite/MPX program signal is up to 10dBu. The same 0-4V RDS subcarrier level range is available in this mode.

SETTING SUBCARRIER AMPLITUDE

Injection level is best set with a modulation monitor that includes a subcarrier measurement utility. Alternatively, a basic mod-monitor can be used alone, but program modulation and the stereo pilot must be turned off to resolve the low RDS injection level.

NOTE: If using a mod-monitor that does *not* have separate subcarrier measurement ability, keep in mind that mod-monitors are *peak-responding* for total modulation readings near 100% modulation, but may be *average-responding* for measurements at low levels of modulation. Because the RDS subcarrier is a complex, suppressed-carrier double-sideband signal, an average reading of 3% RDS injection can represent a level that is substantially higher when measured peak-to-peak. It is the *peak* level we are interested in with broadcasting.

Perhaps a better means of setting injection when a subcarrier monitor is not available is simply to bridge the input of the exciter with an oscilloscope using a BNC “T” adapter. With the audio program muted, the peak-to-peak value of the 19kHz stereo pilot signal can be noted. With this figure in mind, turn off pilot modulation (but do not *disconnect* the stereo generator) and set the peak-to-peak value of the RDS subcarrier to about one-third of the measured 19kHz pilot level. When programming is restored, the mod-monitor should indicate a 3% increase in total modulation, though this may be difficult to resolve near the 100% mark. Readjust the output level of the stereo generator to fine-tune the original total-mod figure.

In the United States, the FCC permits an extra 5% modulation for each subcarrier, with total modulation not to exceed 110% even with two or more subcarriers.

SUBCARRIER PHASE

In the interest of maintaining optimum carrier modulation by the program signal, the 57kHz RDS subcarrier should be in quadrature with the 19kHz stereo pilot. Both in-phase and *quadrature* relationships are shown here in figures below, respectively. Note that a quadrature relationship yields a slightly lower peak level, which allows the greatest carrier modulation by the program audio signal.

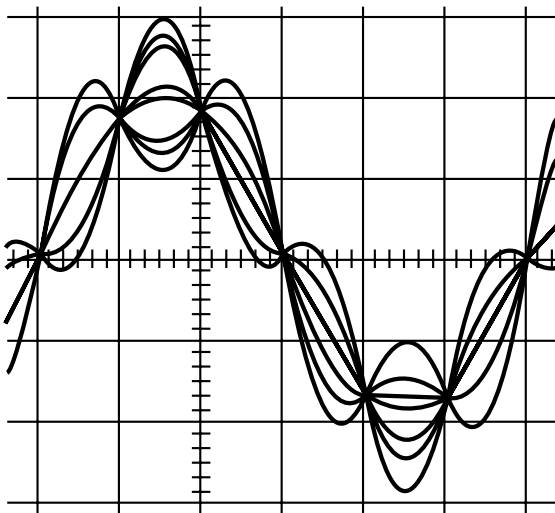

Subcarrier in-Phase

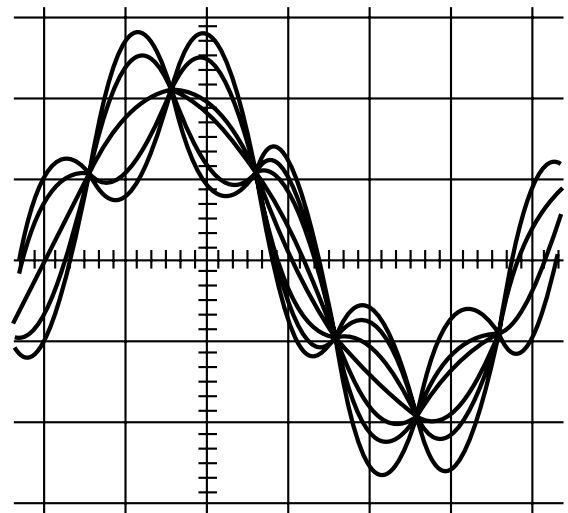

Subcarrier in Quadrature

The SmartGen Mini has the ability to smoothly adjust the phase of the generated RDS signal to the PILOT tone. Although some stereo generators supply a pilot-sync reference for RDS (usually a TTL-level squarewave), this reference may or may not be in exact phase with the actual stereo pilot component of the composite/MPX signal. For this reason we recommend using the composite/MPX signal for synchronization. In the sidechain mode, the SmartGen Mini simply bridges the output of the stereo generator and does not load or otherwise compromise the composite/MPX signal.

Programming Options

ADVANCED PROGRAMMING FOR STATION AUTOMATION

Developed as a fully 'interactive' RDS encoder, the SmartGen Mini can interconnect directly with station automation to transmit dynamic messaging to the receiver. Examples of this are song title and artist information, weather reports or air personality ID. Station automation communicates with the SmartGen Mini through an USB or LAN interface.

The data stream from a station automation system must be formatted properly for communication with the SmartGen Mini encoder. Commands require proper preambles, or headers, so that the SmartGen Mini interprets dynamic data as valid command sets.

SIMPLIFIED WINDOWS® DATA-ENTRY SOFTWARE

To help get RDS on-air quickly and painlessly, a very simple and intuitive Windows® interface has been included on the CD-ROM that comes with the SmartGen Mini encoder. This can be used by anyone to set the static IDs and flags, to program default entries into the dynamic messaging fields, and to set other operating parameters that affect how data from station automation is displayed on the radio faceplate.

Terminal Configuration

Configuration of the terminal, computer or automation system obviously will depend on parameters placed by hardware and firmware. For simplicity, the encoder ASCII programming illustrations in this section will utilize HyperTerminal, the terminal emulation program by Hillgraeve, Inc., developed for Microsoft and supplied with the Windows® operating system. It is hoped that programming instructions based on terminal emulation will help the programmer understand what ASCII syntax the encoder requires, serving as an example for direct-connection with station automation.

If using HyperTerminal, it's best first to upgrade to the latest version. Download this from www.hillgraeve.com/hpte. The more current product seems to run more smoothly and has text editing features not found in earlier versions.

NOTE: Do not connect the SmartGen Mini Encoder until the HyperTerminal program has been configured properly.

HyperTerminal is started under Windows® with the command routine: Start / Programs / Accessories / Communications / HyperTerminal. Double-click: HyperTrm.exe. This brings up the main HyperTerminal screen with a Connection Description window for naming your encoder communications program. How this connection is configured depends on the TCP/IP port will be addressed.

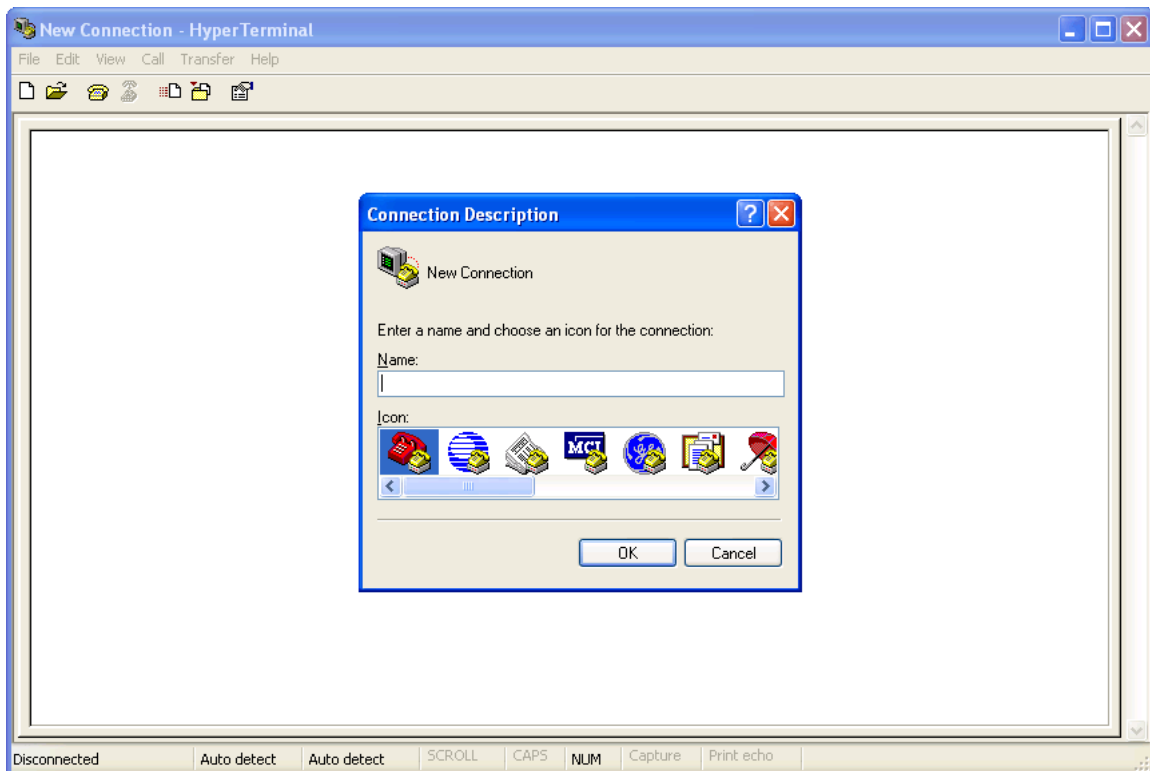

TCP/IP PORT CONFIGURATION

Give the encoder connection a name; we have chosen 'RDS' for this illustration. Click *Connect using* and select TCP/IP (Winsock). In the *Host Address* and *Port Number* enter respectively device IP and Port which must be known in advance. Click OK.

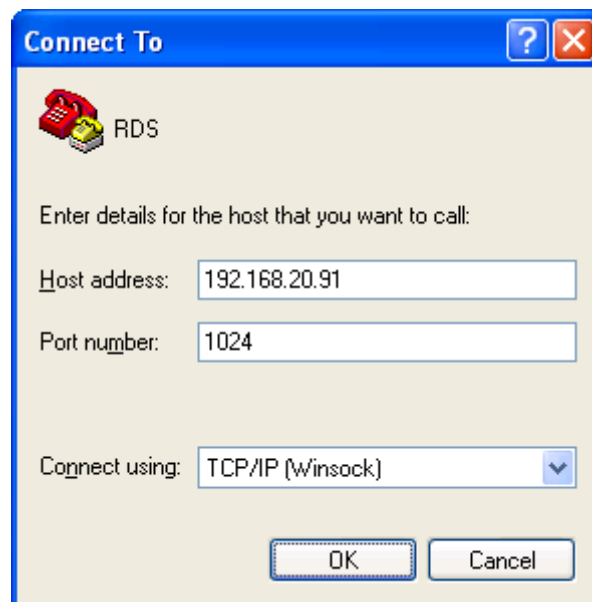

POWER-UP

Once the encoder is connected (by the TCP/IP port) and powered-up, communications should be automatic. A notation at the bottom of the HyperTerminal screen verify connection.

Type: RDS?↵ . This will cause the encoder to send back the contents of all ID, flag and message registers, which (shown here) are the data entered previously. RDS? can be used at any time to make the encoder 'spill its guts'. This exercise does not interrupt or interfere with encoder operation.

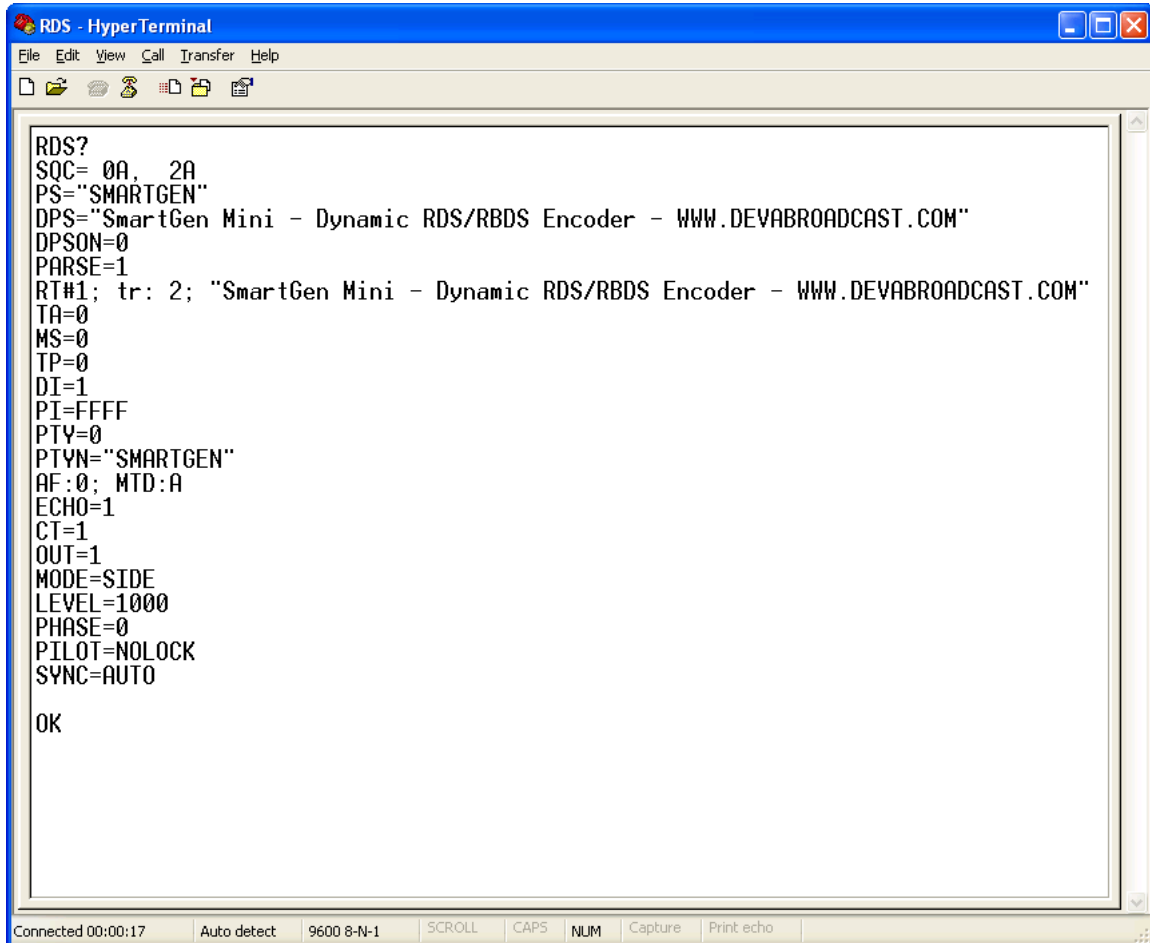

```
RDS?  
SQC= 0A, 2A  
PS="SMARTGEN"  
DPS="SmartGen Mini - Dynamic RDS/RBDS Encoder - WWW.DEVABROADCAST.COM"  
DPSON=0  
PARSE=1  
RT#1; tr: 2; "SmartGen Mini - Dynamic RDS/RBDS Encoder - WWW.DEVABROADCAST.COM"  
TA=0  
MS=0  
TP=0  
DI=1  
PI=FFFF  
PTY=0  
PTYN="SMARTGEN"  
AF:0; MTD:A  
ECHO=1  
CT=1  
OUT=1  
MODE=SIDE  
LEVEL=1000  
PHASE=0  
PILOT=NOLOCK  
SYNC=AUTO  
  
OK
```

All valid interrogations are followed by: OK; a NO shows that the interrogation was not valid. Any single parameter in a register can be interrogated independently. Simply type the register designation followed by a single question mark. A response shown at the right for the typed command: PI?↵

```
OK  
PI?  
3D44  
OK  
-
```

ECHO

It's best for your computer screen to display what has been "echoed" by the encoder as data is entered. Each character typed on the keyboard is sent to the encoder, which turns it back around to be shown on the monitor screen. This round trip gives continuous confirmation of 2-way communications. Typing `ECHO=1` ↵ will provide this round-trip communications verification.

The return data path is not essential, however. The SmartGen Mini will accept programming commands on a receive-only basis. For example, a studio-transmitter radio link (STL) may include 1-way data transmission that could be used to address the encoder.

If double characters appear when typing, your terminal has been configured for local echo. Rather than defeating the echo function of the encoder, local echo should be turned off. This is usually a software command in the terminal or terminal program. Local echo must be used with a 1-way link, however, so that the terminal screen will show what is typed.

The SmartGen Mini has been set to echo as the factory default. The command to turn echo off is `ECHO=0` ↵. To turn echo back on again, type `ECHO=1` ↵.

ASCII Programming Syntax

HOW TO TYPE

In these programming instructions the exact ASCII syntax to be entered on the keyboard will be given in the font used in this example: `DPS=HELLO↵`. Specifically, the field: DPS, the equal sign and the word HELLO would be typed, followed immediately by pressing the Enter key. We will use ↵ as the symbol for Enter.

USING ALL-CAPS

Programming commands should be typed in ALL CAPS (capital letters) and messages should be kept as simple as possible. Though the encoder will accept lowercase letters and all ASCII punctuation in the DPS and TEXT fields, RDS radio displays have limited character sets and may show ambiguous lowercase characters or gibberish. To assure readability, keep the keyboard Caps Lock key engaged and avoid fancy punctuation. ‘Smileys’ are not a good idea.

CORRECTING MISTAKES

Under HyperTerminal, use the Enter key to drop to a new line, if required, and use either the Backspace key or the keyboard’s directional arrows to navigate within a text entry. Overtyping an entry will automatically replace the previous characters. What is shown on the screen before the Enter key is pressed is what will be sent to the encoder.

VALIDITY SYMBOLS

The SmartGen Mini ignores ASCII inputs that do not conform to proper formatting rules. This is an important feature when the encoder is connected full-time to station automation. When a valid command is accepted by the encoder, it returns OK to the computer screen. If a data input is properly formatted, but is ambiguous or otherwise not accurate, the screen will display NO. Examples of valid and invalid commands are shown below. Follow programming instructions *exactly* to ensure that commands will be accepted.

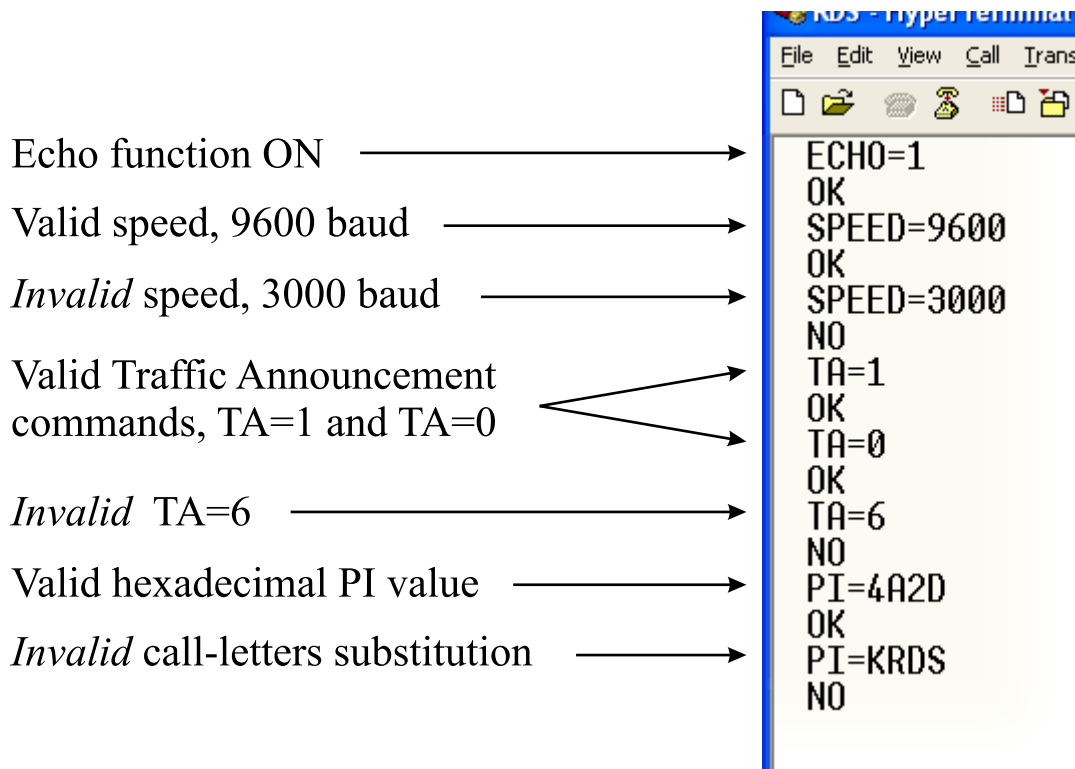

Encoder Housekeeping Commands

REGISTER INTERROGATION

Typing: RDS?`↵` returns the status of all flag and ID settings and the contents of static message buffers to the screen. This was illustrated in section [“Power-Up” on page 32](#)“.

ENCODER INITIALIZATION

The “initialize” command is invoked by typing: INIT`↵`. This is used to reestablish encoder operation in the unlikely event of an internal software ‘crash,’ or for any other reason to restore all the factory defaults (see [“Factory Defaults” on page 40](#)). INIT`↵` is an emergency recovery command only. It is not necessary to execute INIT`↵` prior to updating any encoder programming.

ENCODER RESET

Typing: RESET`↵` initiates a ‘hardware reset’ equivalent to turning the encoder off and back on again. This reset command does not clear the registers of programming commands that have been saved as described above.

FIRMWARE VERSION

Type: REV?`↵` for a display of the encoder’s firmware version. This might prove important in determining whether differences exist between SmartGen Mini encoders purchased at different times.

NETWORK SETTINGS

Type: NET?`↵` for a display of the encoder’s Network Settings, which include IP Address, Subnet Mask, Gateway, DNS Server and DHCP Client. This is useful when information about Network Settings is needed at a glance, instead of interrogate each one Network Parameter.

Listing of Encoder Commands and Prompts

Command	Description
PI	Program Identification, 4 digit HEX number (station “digital address”)
PS	Program Service Name, 8 (max) ASCII characters (station “street name”)
DPS	Dynamic PS, 64 (max) ASCII characters (for messaging in PS field)
DPSON	Dynamic PS ON/OFF, 0 or 1 (0 = OFF, 1 = ON)
PTY	Program Type, 0 to 31 (describes station format)
PTYN	Program TYPe Name, 8 (max) ASCII characters (describes current PTY)
TP	Traffic Program, 0 or 1 (0 = NO, 1 = YES)
TA	Traffic Alert, 0 or 1 (0 = flag OFF, 1 = flag ON)
DI	Decoder Information, 0 to 15
MS	Music/Speech, 0 or 1 (0 = speech-only, 1 = music)
TEXT	RadioText, 64 (max) ASCII characters
SPEED	COM Speed, 75, 150, 300, 600, 1200, 2400, 4800, 9600, 19200, 38400, 57600, 115200 bps. NOTE: SPEED could be get/set only on RS-232 connection
AFA	Sets Alternative Frequencies List using method A. Up to 25 comma delimited Frequencies in range 87.6 to 107.9 MHz Example: AFA=101.8, 99.9
AFB	Sets Alternative Frequencies List using method B. Up to 100 comma delimited Frequencies in range 87.6 to 107.9 MHz Example: AFB=101.8T, 99.9S, 90.5R Tuning Frequency is denoted with following ‘T’ (e.g. 101.8T) Tuning Frequency must be entered always first. Same Program is denoted with following ‘S’ (e.g. 99.9S) Regional Program is denoted with following ‘R’ (e.g. 90.5R)
TATIME	TA Timeout, 0 to 255 minutes (0 = OFF)
ECHO	Command Echo, 0 or 1 (0 = ECHO OFF, 1 = ECHO ON)
PARSE	Dynamic PS Method, 0 to 9 0 = centered, 9 = left justified, 1-8 = N characters at a time
G	G=BBBBCCCCDDDD BBB,CCCC and DDDD are the RDS B,C and D data blocks
H	H=BBBBCCCCDDDD, (see G), TP and PTY are preserved
SQC	Group Sequence, 0A to 15A, 0B to 13B. Example: SQC=0A, 2A, 10A NOTE: 4A, 14B, 15B are not allowed. 2A and 2B could not coexist. Group Sequence could not be empty!

Command	Description
RT+TAG	Radiotext+ tagging data (00-63, 00-63, 00-63, 00-63, 00-63, 00-31, 0-1, 0-255). Eight comma delimited decimal numbers with RT+ tagging data in following order: Tag 1 "Type", Tag 1 "Start", Tag 1 "Length", Tag 2 "Type", Tag 2 "Start", Tag 2 "Length", item running bit value and data timeout (0=NO TIMEOUT, 1-255 timeout minutes).
RT+TPL	Set the RT+ information in group 3A such as CB flag, Server Control Bits and Template number(0-65535).
MODE	Operating Mode, 0 or 1 (LOOP or SIDE) 0 = loop-through, 1 = sidechian
OUT	Switch RDS output signal ON or OFF, 0 = OFF, 1 = ON
SYNC	Selects the synchronization source of the RDS subcarrier, 0 to 2, (AUTO, INT or EXT), 0 = AUTO, 1 = INT, 2 = EXT
TIME	UTC Time, HH:MM:SS (HH=hour, MM=Minutes, SS=Seconds)
DATE	Date, DD.MM.YY (DD=Day, MM=Month, YY=YEAR)
CT.OFFSET	Local Time offset, -15:30 to +15:30, in multiples of half hours
SNTP	Switch SNTP Client ON or OFF, 0 = OFF, 1 = ON
IP	IP Address, XXX.XXX.XXX.XXX
MASK	Subnet Mask, XXX.XXX.XXX.XXX
GATEWAY	Gateway, XXX.XXX.XXX.XXX
DNS	DNS Server, XXX.XXX.XXX.XXX
DHCP	Switch DHCP Client ON or OFF, 0 = OFF, 1 = ON
IPPORT1	Sets TCP Port 1, 1024-65535
IPPORT2	Sets TCP Port 2, 1024-65535
IPPORT3	Sets UDP Port 1, 1024-65535
IPPORT4	Sets UDP Port 2, 1024-65535
HTTPPORT	Sets HTTP(WEB) Port, 80(default) or 1024-65535. NOTE: All Network Ports must be unique
LEVEL	RDS subcarrier Level in mVp-p, 0-4095
PHASE	RDS subcarrier Phase in degrees, 0 to 3599, 1 = 0.1 degree
CT	Switch transmission of 4A group ON or OFF, 0 = OFF, 1 = ON
DST	Daylight Saving Rule, 0 to 3,(0=OFF, 1=AUTO EU, 2=AUTO USA, 3=MANUAL)
Use '=' to SET parameter value, e.g.: PI=1234	
Use '?' to GET parameter value, e.g.: TIME?	

SPECIAL COMMANDS	
Command	Description
RDS?	Returns all data in encoder memory
NET?	Returns all Network settings
REV?	Returns firmware & hardware revision numbers
PILOT?	Returns the Status of the 19 kHz PLL. LOCK - locked to the 19kHz stereo pilot signal. NOLOCK - defaulted to the internal timebase
AF?	Returns the current AF list
AF.CLEAR	Clears the current AF list
SNTP.SYNC	Forces SNTP to synchronize immediately
ISDST?	DST is in effect? (1 = DST is observed, 0 = DST is not observed)
RESET	Resets the encoder as if AC power were cycled off and on
GRMON?	RDS groups counters
GRMONINI	Clears the RDS groups counters
UPTIME?	Returns device uptime
RESET	Resets the encoder as if AC power were cycled off and on
INIT	Initializes the encoder to all factory defaults
CLS	Clears the Terminal Screen
Response	Meaning
OK	Command received by encoder properly formatted and understood
NO	Command properly formatted but data not understood
ACCESS DENIED	Command is disabled for this port by Access Rights

DON'T FORGET that all the static RDS registers, including simple scrolling messages, can be entered or changed easily through either the Windows® or network data entry screens.

Factory Defaults

NETWORK SETTINGS

IP	192.168.1.2
Gateway	192.168.1.1
Subnet Mask	255.255.255.0
DNS	192.168.1.1
DHCP	Disabled
TCP PORT 1	1024
TCP PORT 2	1025
UDP PORT 1	5001
UDP PORT 2	5002
HTTP Server Port	80
WEB Server Username	user
WEB Server Password	pass

NOTE: Network Settings will not be affected when Factory Defaults are issued through LAN interface.

GENERAL SETTINGS

RDS Standard	RDS
RDS Level	1000mVpp
RDS Phase	0.0°
Output Mode	Sidechain
RDS	On
Syncrhro Source	Auto
Site Name	SmartGen 4.1
CT	On
Daylight Saving Time	Off
SNTP	On
Local Time Offset	0
RTC Correction	0

BASIC RDS SETTINGS

PI	FFFF
PTY	None
PS	SMARTGEN
PTYN	SMARTGEN
TA	OFF
TP	OFF
TA Timeout	0 (Off)
MS	Music
DI(0)	Stereo
DI(1)	No Artificial Head
DI(2)	Not Compressed
DI(3)	Static PTY
RT	SmartGen Mini - Dynamic RDS/RBDS Encoder - WWW.DEVABROADCAST.COM
A/B Flag	On
Dynamic PS	Off
Parse	1 char
DPS Text	SmartGen Mini - Dynamic RDS/RBDS Encoder - WWW.DEVABROADCAST.COM
AF List	Empty

UECP SETTINGS

Site Address List	Empty
Encoder Address List	Empty
Current DSN	1
Main PSN	1
Selected Reference Input	1
Group Sequence	0A, 2A
Access Rights	Access Granted on all ports

WEB Configuration

SmartGen Mini can be accessed through Internet using a web browser of choice. No additional software is required.

To access Device Web Interface it is necessary to know what IP address is assigned to device. ([see “Network Settings” on page 36](#)) and device password.

Into browser’s address field type device IP, e.g. http://192.168.20.16. Depending on browser it may be required to specify port, which is appended after IP address and in our default case must be :80.

ATTENTION: Depending on Internet Protocol Settings, assigned IP address may not be visible outside your local network, thus device may be accessed only within that network. Consult with your network administrator for the appropriate IP settings.

Username and Password will be requested when connecting for the first time. Default values are *user* and *pass*.

The WEB interface is visually divided into two sections:

1. On top of the control window is placed constant section containing all the mandatory settings and statuses. This section is intended to allow fast reading of these parameters and is a permanent part of the WEB Interface.
2. Below this section is placed the content of each tab that enables the set-up of the RDS/RBDS encoder - Basic RDS, AF List/Group Sequence, Monitor.

BASIC RDS

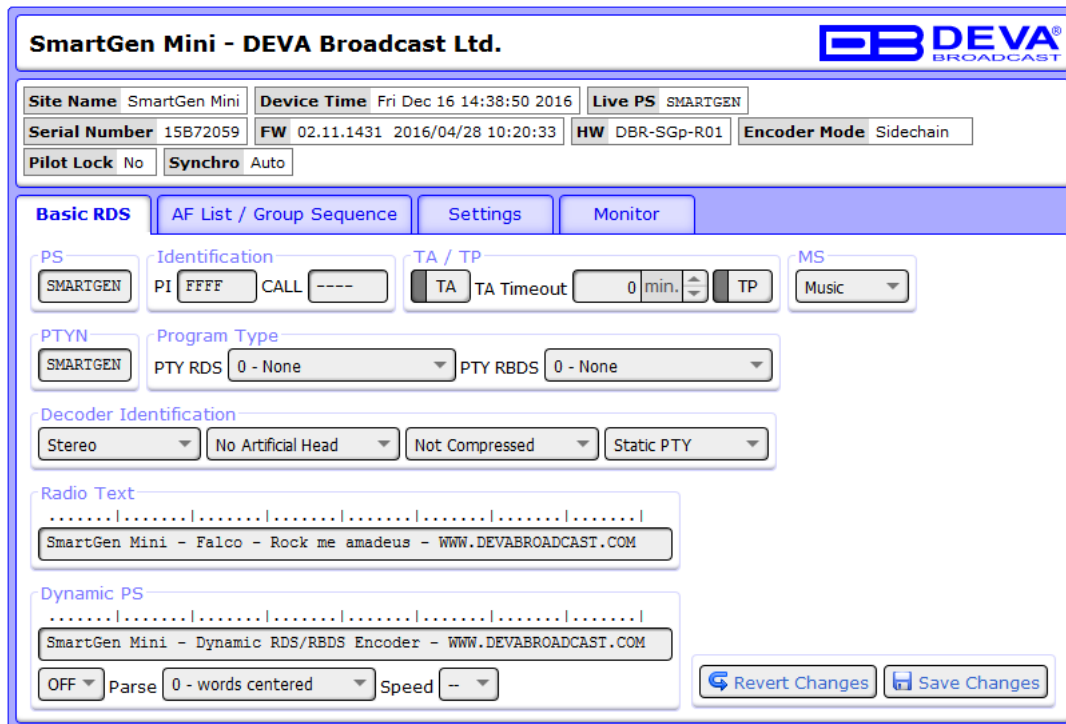

In this tab you will find all the essential RDS parameters needed for the Basic RDS applications.

PS (Program Service Name) – This is the station’s “street name” that will appear on the receiver faceplate display. The *PS* can be up to eight characters in length (including spaces) and can be as simple as the station’s call letters: KWOW or KWOW FM, or a slogan: NEWSTALK or LIVE 95.

Identification - PI/CALL – The *PI* code is your station’s ‘digital address’. It is a hexadecimal code that is assigned by an appropriate broadcasting authority in most countries, but in the United States the *PI* code is numerically calculated from the station’s call sign. We have provided a calculator utility within the encoder. An in-depth discussion of the mathematical calculation is given in RDS/RBDS Standard.

To use the *PI* calculator for US ‘K’ and ‘W’ call signs, simply enter call letters into the CALL box. The hexadecimal code will automatically be calculated into PI box. If the hexadecimal code for a US station is known, you may enter it under PI, and then the call sign will be calculated automatically into *CALL* box. When PI calculator fails to calculate PI or CALL the corresponding box will be filled with ‘----’.

TP (Traffic Program Identification) – The *TP* flag identifies the station as one that routinely broadcasts traffic bulletins for motorists as part of its normal, everyday programming. When the *TP* flag is displayed on the receiver faceplate, the radio is searching for traffic announcements. The radio keeps track of TP stations offering this service to speed up the search-and-switch process.

TA (Traffic Announcement) – This is a temporary flag added to the RDS data stream only when a traffic bulletin is being aired. Some RDS car radios can be set to search for traffic bulletins among various *TP* stations while tuned to a listener’s preferred program, or even while playing a tape or CD. As soon as any *TP* station broadcasts a traffic bulletin, the receiver temporarily switches-over to receive it. When the bulletin is finished, the receiver switches back to the original program, tape or CD.

MS (Music/Speech Switch) – This flag simply indicates whether music or speech is the primary broadcast programming.

PTYN (Program Type Name) – Program Type Name is transmitted as 8-bit characters. *PTYN* must only be used to enhance Program Type information and it must not be used for sequential information. PTYN Enable – [Enable] or [Disable] type 10A Group Transmission. This group allows further description of the current Program Type.

PTY (Program Type) – The *PTY* data flag identifies the station format from a pre-defined categories. Many RDS receivers are able to seek the listener’s preferred format automatically.

This means that a car radio can switch from a fading station to a stronger one that carries the same variety of music, though not the very same program, as provided by AF switching. The *PTY* function of RDS helps a broadcaster catch ‘transient audience’ share. The *PTY* code is not meant to change from song to song or to accommodate a top-of-the-hour newscast, however.

DI (Decoder Identification) – This is one of several ‘flags’ that convey yes/no or other very basic data. This flag helps the receiver to indicate whether the broadcast is monaural or is transmitted in any of several methods of stereo or binaural broadcasting. As many as 16 encoding options may be accommodated! This is a rather esoteric function and, thus far, remains unused both in Europe and in the US.

RT (Radio Text) – This is a 64-character block of plain text that the listener can select for visual display on the faceplate of the radio by pressing an INFO button on the receiver. This function is not available on many automobile radios for safety reasons, which has precipitated the frowned-upon practice of scrolling the PS field instead. The Radio Text can announce song titles and performers, run special promotions or contests, or broadcast sponsors’ messages.

Dynamic PS ‘marches’ the message across the display screen one character at a time. The message requires a much longer transmission time in this mode, but a glance at the radio display a few seconds still allows the driver to get the full message without missing words.

Scroll Speed – The speed of dynamic PS messaging is set here, or dynamic PS messaging can be turned off entirely. When 0 - *DPS* Disabled is selected, the dynamic PS message remains in the nonvolatile encoder memory, but only the 8-character default static “street name” typed into the PS field (Basic RDS) will be displayed on the receiver faceplate. Setting the speed at 1 - Slowest will result in the slowest refresh rate of the ‘block’ message, or slowest safe scrolling. 9 - Fastest is the fastest speed, but many RDS radios display gibberish at high speed settings. The display should be stable with any radio at a speed setting of 7 or lower.

Parse Mode – sets the scroll step to be used in the “block” mode message transmission, more popular as ‘grouped-word’ method. Once Parse Mode option is set, this encoder function is valid for any scrolling-PS message, whether it is entered into the static DPS register, or received as ASCII text from station automation. Very short words are sent together in groups. For example, THIS IS constitutes seven characters that can be sent as a group. The same is applicable for OF THE or NOW HERE, also. Longer words, up to and including 8 characters, are sent individually: WARNING or DOUGHNUT or BICYCLE. The device can either center words that are sent individually on the radio display or left-justify them. This will be covered along with the function of the ‘DPS Scroll Step’. Words that exceed the available 8 characters are ‘sidestepped’ through two or more consecutive displays. Examples: EMERGENC followed by MERGENCY, or SUPERMAR followed by UPERMARK and PERMARKE and ERMARKET. This method of splitting words gives a good sense of continuity and readability. Setting Parse Mode to 1 - Scroll by 1 letter will scroll the message one character at a time, as described. Other numbers also safe-scroll the message, but at 2, 3, 4, and up to 8 characters at a time. Selecting 9 - Left Justified will parse, as described, but text will be left-justified rather than centered on the display. 2 through 8 may be useful in some special RDS applications, but 0 and 1 are the primary Parse Mode selections. To recap: 0 - Centered will enable the more-popular, centered-auto-parsed block mode and 1 - Scroll by 1 letter the Dynamic PS, letter-by-letter option.

WHEN APPLYING NEW SETTINGS – In order new settings to take effect, it is necessary to press the [Save changes] button. Please keep in mind that some of the new settings can reset the encoder.

AF LIST / GROUP SEQUENCE

SmartGen Mini - DEVA Broadcast Ltd.

Site Name SmartGen Mini	Device Time Fri Dec 16 14:38:50 2016	Live PS SMARTGEN	
Serial Number 15B72059	FW 02.11.1431 2016/04/28 10:20:33	HW DBR-SGp-R01	Encoder Mode Sidechain
Pilot Lock No	Synchro Auto		

Basic RDS
AF List / Group Sequence
Settings
Monitor

AF List

Method

A	B
---	---

+ Add AF
Clear

Group Sequence

0	A	B	X	↑	↓
2	A	B	X	↑	↓

+ Add Group
Clear

Revert Changes
Save Changes

At the left side is shown AF List. At the right side is shown Group Sequence. To add new AF Method or Group sequence, follow the instructions below.

How to add a new AF Method A

The screenshot shows the 'SmartGen Mini - DEVA Broadcast Ltd.' interface. At the top, there are fields for Site Name (SmartGen Mini), Device Time (Fri Dec 16 14:38:50 2016), Live PS (SMARTGEN), Serial Number (15B72059), FW (02.11.1431 2016/04/28 10:20:33), HW (DBR-SGp-R01), Encoder Mode (Sidechain), Pilot Lock (No), and Synchro (Auto). Below this are tabs for Basic RDS, AF List / Group Sequence, Settings, and Monitor. The AF List / Group Sequence tab is active, showing two panels: 'AF List' and 'Group Sequence'. The 'AF List' panel has a 'Method' dropdown with 'A' selected (1), a frequency input field with '87.6' (3), and 'Add AF' (2) and 'Clear' buttons. The 'Group Sequence' panel has a table with columns for Method A and B, and buttons for adding, deleting, and moving items. At the bottom right are 'Revert Changes' and 'Save Changes' buttons.

1. Select Method A;
2. Press [+Add AF];
3. Specify frequency by typing it in the relevant field, or via the [Up] and [Down] buttons, placed on the right of the frequency box;
Repeat steps from 2 to 3 for all AF Method A to be added;
4. Press [Save Changes].

How to add a new AF Method B

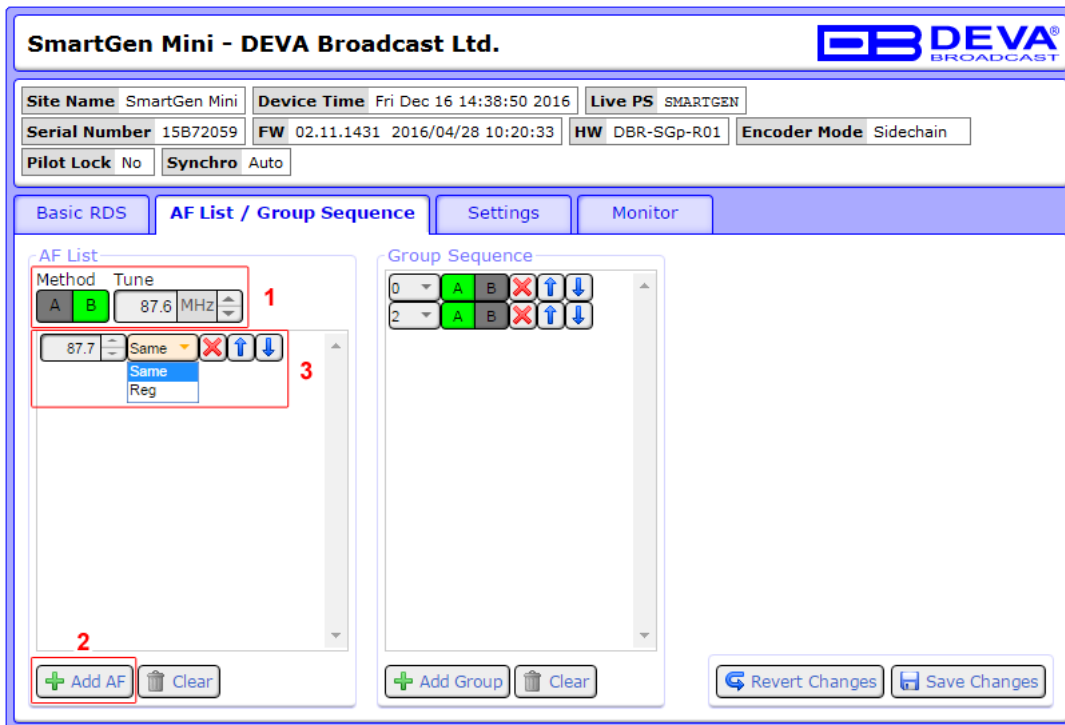

1. Select Method B and tuning frequency (Tune);
 2. Press [+Add AF];
 3. If not already done that, specify frequency by typing it in the relevant field, or via the [Up] and [Down] buttons, placed on the right of the frequency box. Then from the drop-down menu specify Same or Reg;
- Repeat steps from 2 to 3 for all AF Method B to be added;
4. Press [Save Changes].

Add Group Sequence

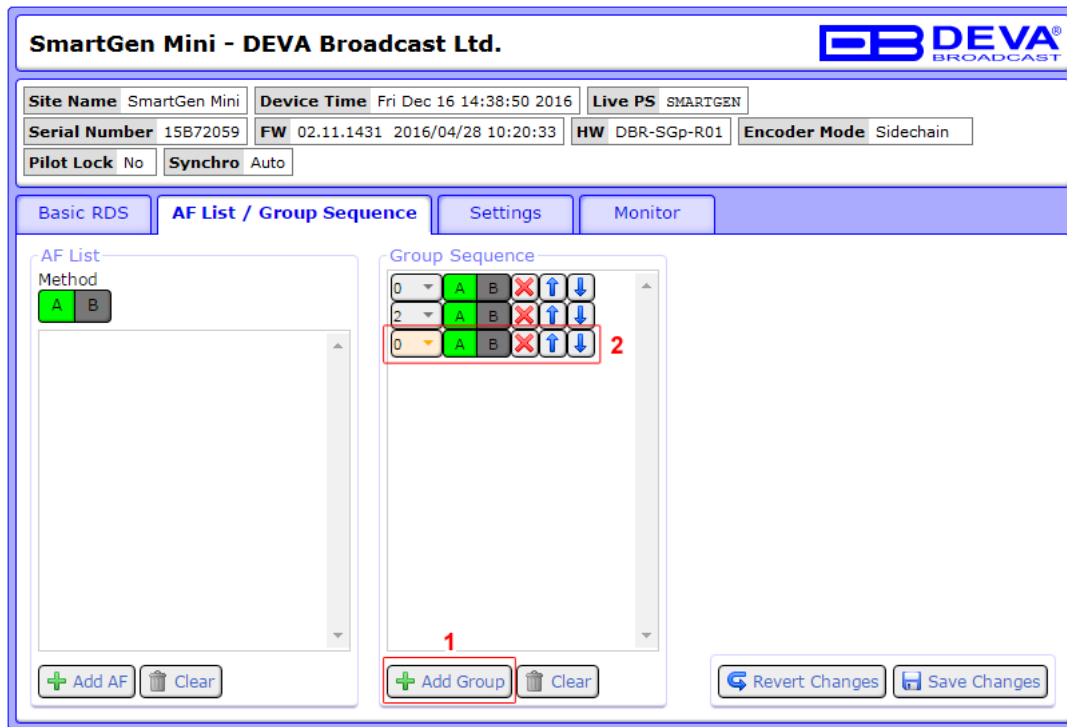

1. Press [+Add Group];
 2. Select the group number from the drop-down menu. Then from specify method to be used – A or B;
- Repeat steps from 1 to 2 for all Groups to be added;
3. Press [Save Changes].

SETTINGS

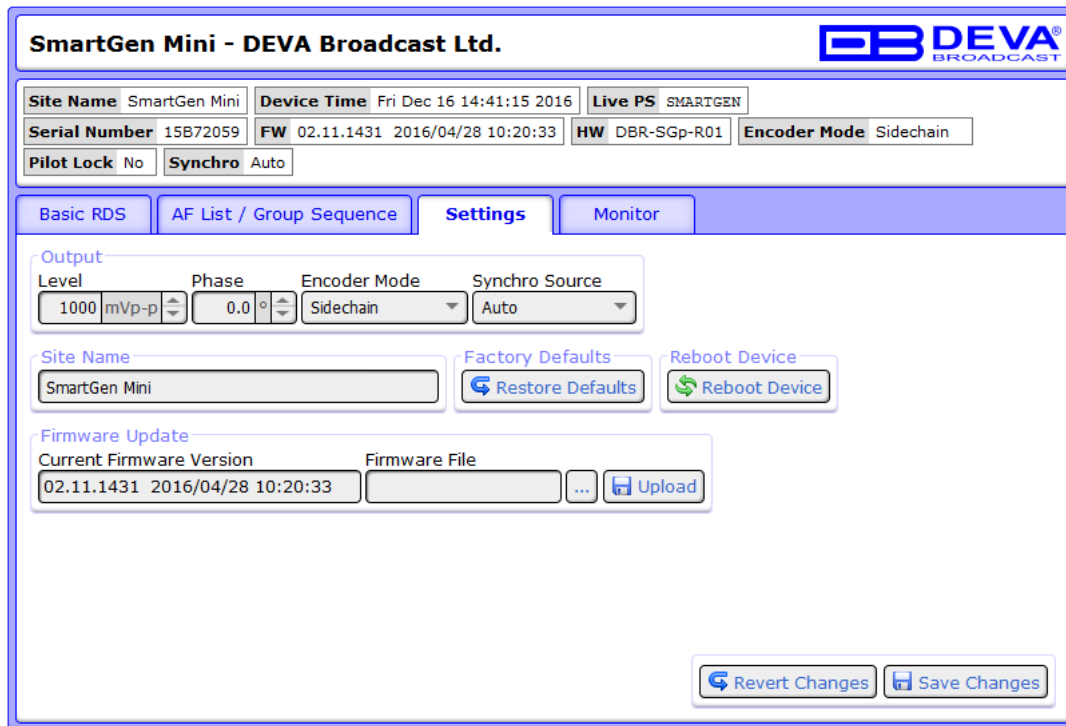

SmartGen Mini - DEVA Broadcast Ltd.

Site Name: SmartGen Mini | Device Time: Fri Dec 16 14:41:15 2016 | Live PS: SMARTGEN
 Serial Number: 15B72059 | FW: 02.11.1431 2016/04/28 10:20:33 | HW: DBR-SGp-R01 | Encoder Mode: Sidechain
 Pilot Lock: No | Synchro: Auto

Basic RDS | AF List / Group Sequence | **Settings** | Monitor

Output
 Level: 1000 mVp-p | Phase: 0.0 ° | Encoder Mode: Sidechain | Synchro Source: Auto

Site Name: SmartGen Mini | Factory Defaults: Restore Defaults | Reboot Device: Reboot Device

Firmware Update
 Current Firmware Version: 02.11.1431 2016/04/28 10:20:33 | Firmware File: [Empty] | Upload

Revert Changes | Save Changes

Contains information as regards the encoder’s information and allows set-up of the encoder’s **Output** and **Site Name**. **Factory defaults**, **Reboot Device** and **Firmware update** could also be performed via this tab.

The RDS Level is digitally adjusted. Section Output allows **Level**, **Phase**, **Encoder Mode** (Side-chain or Loop-through) and **Synchro Source**. The Synchro Source selects the synchronization source of the RDS subcarrier - Auto, Internal or External.

Section **Site Name** – is mainly used for informational services. It allows custom name to be set, so as the encoder could be more distinctive.

Pressing the [Factory Defaults] button will return the device to its factory defaults.

Pressing the [Reboot Device] will reboot the device.

Firmware Update contains information of the Current Firmware Version, and also allows the device’s Firmware to be updated.

FIRMWARE UPDATE

- To update the device firmware, please follow the next steps:
- Select the new firmware file by pressing the [...] (‘Browse’) button;
- Press the “Upload” button;
- Wait for the process to complete.

MONITOR

SmartGen Mini - DEVA Broadcast Ltd.

Site Name SmartGen Mini	Device Time Fri Dec 16 14:41:35 2016	Live PS SMARTGEN	
Serial Number 15B72059	FW 02.11.1431 2016/04/28 10:20:33	HW DBR-SGp-R01	Encoder Mode Sidechain
Pilot Lock No	Synchro Auto		

Basic RDS
AF List / Group Sequence
Settings
Monitor

Group Detector

Total Groups: 1003222 Count Reset Counters

	0	1	2	3	4	5	6	7	8	9	10	11	12	13	14	15
A:	301k		701k		1k											
B:																

Device Uptime

Uptime: 1 day, 00:47:08

Total Groups Indicator – all received groups are systematized into a table, representing the percentage/quantity of the groups in the received RDS/RBDS signal. The user selects how the “Total groups received” data should be represented: as Percents (%) or as Count, by selecting the corresponding button.

[Reset Counters] – will reset the table content.

Device Uptime – measures the time that the RDS/RBD Encoder has been working.

APPENDIX A

RDS: EUROPE VS AMERICA

The European Broadcasting Union (EBU) and its member countries originated the concept of “Radio Data” transmission. The European RDS specification, CENELEC Standard EN50067, was first published in 1984. It was revised in 1986, 1990, 1991 and 1992.

European RDS has grown in use following initial adoption of the Standard. RDS is nearly universal throughout Europe; it is almost impossible to find a European FM broadcasting station that does not carry a radio data subcarrier.

The popularity of RDS in Europe is very much in contrast with initial reluctance on the part of US broadcasters to embrace this technology. This can be ascribed to material differences in broadcasting practices.

Almost without exception, FM broadcasting in the United States is ‘detached’ and independent - each station originates its own programming. America’s National Public Radio might be considered as an exception, though for most of the broadcast day even NPR stations originate, or at least schedule, their own programs.

Most of European broadcasting is similar to the concept of network radio that was common in the US prior to the 1950s. In Europe, a central program originator may have many transmitting facilities of modest power situated throughout the country, at several different frequencies to blanket a designated service area. The European disposition, toward lower-power transmitters can be found on the “local radio” level, as well.

The European concept of a service area equates to the US broadcaster’s market. The subtle difference between these designations further characterizes broadcasting practices and ethics. RDS benefits the European broadcaster through almost an altruistic endeavor to be of service to his listeners. The US broadcaster is marketing his programming and is primarily interested in how he can create additional revenue from RDS.

THE RDS SYSTEM

RDS is a digital data channel, transmitted as a low-level subcarrier above the range of the composite stereo program signal in the FM baseband. The data transmission (baud) rate is comparatively low, yet it is quite robust because of data redundancy and effective error correction.

It is not within the scope of this Manual to cover the details of RDS subcarrier coding and modulation. For this, the reader is directed to the Specification appropriate to his location either the CENELEC EN50067 Specification for Europe or the United States NRSC Specification. Since the Manual will deal with specific implication of RDS implemented with the SmartGen Mini, it is assumed that the user is familiar with the RDS concept.

APPENDIX B.1

PTY Code Description Used in RBDS Mode – North America

PTY	Short Name	Description
1	News	News reports, either local or network in origin.
2	Information	Programming that is intended to impart advice.
3	Sports	Sports reporting, commentary, and/or live event coverage, either local or network in origin.
4	Talk	Call-in and/or interview talk shows either local or national in origin.
5	Rock	Album cuts.
6	Classic Rock	Rock oriented oldies, often mixed with hit oldies, from a decade or more ago.
7	Adult Hits	An up-tempo contemporary hits format with no hard rock and no rap.
8	Soft Rock	Album cuts with a generally soft tempo.
9	Top 40	Current hits, often encompassing a variety of rock styles.
10	Country	Country music, including contemporary and traditional styles.
11	Oldies	Popular music, usually rock, with 80% or greater non-current music.
12	Soft	A cross between adult hits and classical, primarily non-current softrock originals.
13	Nostalgia	Big-band music.
14	Jazz	Mostly instrumental, includes both traditional jazz and more modern “smooth jazz.”
15	Classical	Mostly instrumentals, usually orchestral or symphonic music.
16	Rhythm and Blues	A wide range of musical styles, often called “urban contemporary.”
17	Soft R and B	Rhythm and blues with a generally soft tempo.
18	Foreign Language	Any programming format in a language other than English.
19	Religious Music	Music programming with religious lyrics.
20	Religious Talk	Call-in shows, interview programs, etc. with a religious theme.
21	Personality	A radio show where the on-air personality is the main attraction.
22	Public	Programming that is supported by listeners and/or corporate sponsors instead of advertising.
23	College	Programming produced by a college or university radio station.
24	Spanish Talk	Call-in shows, interview programs, etc. in the Spanish language
25	Spanish Music	Music programming in the Spanish language
26	Hip-Hop	Popular music incorporating elements of rap, rhythm-and-blues, funk, and soul
27-28	Unassigned	
29	Weather	Weather forecasts or bulletins that are non-emergency in nature.
30	Emergency Test	Broadcast when testing emergency broadcast equipment or receivers. Not intended for searching or dynamic switching for consumer receivers. Receivers may, if desired, display “TEST” or “Emergency Test”.
31	Emergency	Emergency announcement made under exceptional circumstances to give warning of events causing danger of a general nature. Not to be used for searching - only used in a receiver for dynamic switching.

NOTE: These definitions can differ slightly between various language versions.

APPENDIX B.2

PTY Code Description Used in RDS Mode – Europe, Asia

PTY	Short Name	Description
1	News	Short accounts of facts, events and publicly expressed views, reportage and actuality.
2	Current affairs	Topical program expanding or enlarging upon the news, generally in different presentation style or concept, including debate, or analysis.
3	Information	Program the purpose of which is to impart advice in the widest sense.
4	Sport	Program concerned with any aspect of sport.
5	Education	Program intended primarily to educate, of which the formal element is fundamental.
6	Drama	All radio plays and serials.
7	Culture	Programs concerned with any aspect of national or regional culture.
8	Science	Programs about the natural sciences and technology.
9	Varied	Used for mainly speech-based programs usually of light-entertainment nature, not covered by other categories. Examples include: quizzes, games, personality interviews.
10	Pop	Commercial music, which would generally be considered to be of current popular appeal, often featuring in current or recent record sales charts.
11	Rock	Contemporary modern music, usually written and performed by young musicians.
12	Easy Listening	Current contemporary music considered to be “easy-listening”, as opposed to Pop, Rock or Classical, or one of the specialized music styles, Jazz, Folk or Country. Music in this category is often but not always, vocal, and usually of short duration.
13	Light classics	Classical Musical for general, rather than specialist appreciation. Examples of music in this category are instrumental music, and vocal or choral works.
14	Serious classics	Performances of major orchestral works, symphonies, chamber music etc., and including Grand Opera.
15	Other music	Musical styles not fitting into any of the other categories. Particularly used for specialist music of which Rhythm & Blues and Reggae are examples.
16	Weather	Weather reports and forecasts and Meteorological information.
17	Finance	Stock Market reports, commerce, trading etc.
18	Children’s programs	For programs targeted at a young audience, primarily for entertainment and interest, rather than where the objective is to educate.
19	Social Affairs	Programs about people and things that influence them individually or in groups. Includes: sociology, history, geography, psychology and society.
20	Religion	Any aspect of beliefs and faiths, involving a God or Gods, the nature of existence and ethics.
21	Phone In	Involving members of the public expressing their views either by phone or at a public forum.
22	Travel	Features and programs concerned with travel to near and far destinations, package tours and travel ideas and opportunities. Not for use for Announcements about problems, delays, or roadworks affecting immediate travel where TP/TA should be used.
23	Leisure	Programs concerned with recreational activities in which the listener might participate. Examples include, Gardening, Fishing, Antique collecting, Cooking, Food & Wine etc.
24	Jazz Music	Polyphonic, syncopated music characterized by improvisation.
25	Country Music	Songs which originate from, or continue the musical tradition of the American Southern States. Characterized by a straightforward melody and narrative story line.
26	National Music	Current Popular Music of the Nation or Region in that country’s language, as opposed to International ‘Pop’ which is usually US or UK inspired and in English.
27	Oldies Music	Music from the so-called “golden age” of popular music.
28	Folk Music	Music which has its roots in the musical culture of a particular nation, usually played on acoustic instruments. The narrative or story may be based on historical events or people.
29	Documentary	Program concerned with factual matters, presented in an investigative style.
30	Alarm Test	Broadcast when testing emergency broadcast equipment or receivers. Not intended for searching or dynamic switching for consumer receivers.. Receivers may, if desired, display “TEST” or “Alarm Test”.
31	Alarm	Emergency announcement made under exceptional circumstances to give warning of events causing danger of a general nature. Not to be used for searching - only used in a receiver for dynamic switching.

APPENDIX C

RDS APPLICATIONS SUPPORTED

Following is an alphabetical list of the RDS applications supported by SmartGen Mini. The standardized RDS application abbreviation is followed by an expansion of the application name and a short explanation of the function.

AF

List of Alternative Frequencies: In order holes in the coverage area to be filled, list of all frequencies where identical program could be heard simultaneously can be included by the network broadcaster or one with low-power rebroadcast transmitters (translators). The RDS receiver (particularly the upscale car radio) constantly searches for the best signal that carries the same program. The radio will re-tune without noticeable interruption, when a better signal is found. The principal utility of this RDS function is with European radio networks and US stations with 'translators.'

CT

Clock Time and date: Time and date codes should use Coordinated Universal Time (UTC) and Modified Julian Day (MJD). If $MJD = 0$, the receiver should not be updated. The listener, however, will not use this information directly and the conversion to local time and date will be made in the receiver's circuitry. CT is used as time stamp by various RDS applications and thus it must be accurate.

DI

Decoder Information: This is one of several 'flags' that convey yes/no or other very basic data. This flag helps the receiver to indicate whether the broadcast is monaural or is transmitted in any of several methods of stereo or binaural broadcasting. As many as 16 encoding options may be accommodated! This is a rather esoteric function and, thus far, remains unused both in Europe and in the US.

ECC

Extended Country Code: RDS uses its own country codes. The first most significant bits of the PI code carry the RDS country code. The four bit coding structure only permits the definition of 15 different codes, 1 to F (hex). Since there are much more countries to be identified, some countries have to share the same code which does not permit unique identification. Hence there is the need to use the Extended Country Code which is transmitted in Variant 0 of Block 3 in type 1A groups and together with the country identification in bits b15 to b12 of the PI code render a unique combination. The ECC consists of eight bits.

EON

Enhanced Other Networks information: This feature can be used to update the information stored in a receiver about program services other than the one received. The alternative frequencies-PS name, Traffic Program and Traffic Announcement identification as well as Program Type and Program Item Number information can be transmitted for each other service. The relation to the corresponding program is established by means of the relevant Program Identification. Linkage information, consisting of four data elements, provides the means by which several program services may be treated by the receiver as a single service during times a common program is carried. Linkage information also provides a mechanism to signal an extended set of related services.

EWS

Emergency Warning System: The EWS is intended to provide coding for warning messages. These messages will be broadcasted only in case of emergency and will be evaluated by special receivers.

FFG

Free Format Groups: A provision has been included in the SmartGen Mini to transmit proprietary data directly within a legitimate RDS group. This is a special use of the encoder for non-standard applications.

IH

In House application: This refers to data to be decoded only by the operator. Some examples noted are identification of transmission origin, remote switching of networks and paging of staff. The applications of coding may be decided by each operator itself.

M/S

Music / Speech Switch: This flag simply indicates whether music or speech is the primary broadcast programming. The purpose of this function is not well explained in the respective Standards; hence it comes as no surprise that it is not widely used.

ODA

Open Data Applications: The Open Data Applications feature allows data applications, not previously specified in EN 50067, to be conveyed in a number of allocated groups in an RDS transmission. The allocated groups are indicated by using type 3A group which is used to identify to a receiver the data application in use in accordance with the registration details in the EBU/RDS Forum - Open Data Applications Directory and the NRSC Open Data Applications Directory.

PI

Program Identification: This block of data identifies the broadcast station with a hexadecimal numerical code, which becomes the “digital signature” of the station. The code is assigned by the broadcasting authorities in most countries, but in the US it is calculated from a numerical encoding of station call letters. The receiver processes the PI code to assist automatic tuning features (station memories), and to prevent false switching to alternative frequencies that might be shared by broadcasters in nearby regions.

PIN

Program Item Number: The code enables the designed to use this feature receivers and recorders to respond to the preselected by the user program item(s). This feature is used via scheduled program time, to which in order to avoid ambiguity is added the day of the month.

PS

Program Service Name: This is the station's "street name" that will appear on the receiver faceplate display. The PS can be up to eight characters in length (including spaces) and can be as simple as the station's call letters: KWOW or KWOW FM, or a slogan: NEWSTALK or LIVE 95. The Program Service Name is automatically displayed, even on the automobile receivers. Because of driving safety considerations broadcasters are generally discouraged from scrolling messages in this field. As a matter of fact, it is a violation of both the CENELEC and the NRSC standards to scroll the PS display, although the practice has become universally common.

PTY

Program Type: The PTY data flag identifies the station format from a collection of pre-defined categories. Many RDS receivers are able to seek the listener's preferred format automatically. This means that a car radio can switch from a fading station to a stronger one that carries the same variety of music, though not the very same program, as provided by AF switching. The PTY function of RDS helps a broadcaster catch 'transient audience' share. A listing of the PTY categories is given in ["PTY Code Description Used in RBDS Mode – North America" on page 52](#) and ["PTY Code Description Used in RDS Mode – Europe, Asia" on page 53](#).

Under some programming circumstances, the PTY identifier may be made 'dynamic,' changing between categories for a station that "dayparts" (changes its format for specific time periods). The PTY code is not meant to change from song to song or to accommodate a top-of-the-hour newscast, however.

PTYN

Program TYpe Name: The PTYN feature allows the predefined by the RDS/RBDS Standard PTY to be further described using user-defined text (e.g. PTY=4: Sport and PTY=8: Football). The PTYN is not intended to change the default eight characters of PTY which will be used during search or wait modes. Its purpose is to show in details the program type once tuned to a program. If the broadcaster is satisfied with the default PTY name, it is not necessary to use additional data capacity for PTYN. The Program Type Name is not intended to be used for automatic PTY selection and must not be used for giving sequential information.

RT

RadioText: This is a 64-character block of plain text that the listener can select for visual display on the faceplate of the radio by pressing an INFO button on the receiver. This function is not available on many automobile radios for safety reasons, which has precipitated the frowned-upon practice of scrolling the PS field instead.

Most radios have limited alphanumeric display capability, so the 64 characters of RadioText march across the front panel, much akin those annoying LED advertising signs found in airport buses or fast food emporia. Like the scrolling-PS implementation, RadioText can announce song titles and performers, run special promotions or contests, or broadcast sponsors' messages.

RT+

RadioText Plus is “semantic analogue radio”. It allows the RDS feature RadioText (RT) to be read by the FM RDS receiving terminals. Based on the RDS RT messages, RT+ is completely backwards compatible with RT. The usage of RT+ allows the listener/user to derive additional benefits from the RDS Radio Text service. It enables FM RDS receivers to “read” Radio Text (to recognize designated objects and make them manageable) by user’s direct access to specific elements of the Radio Text messages. For example, that element could be programme associated metadata like Title and Artist of the currently playing song or a news headlines. This provides the listener with an “mp3-player feeling” while listening to analogue FM radio. The elements can also carry additional service messages or information about the Radio Station such as the telephone number or the web address of the Radio Station’s hotline. These objects, or more accurately RT+ information elements carried in the RDS RadioText (RT) messages, are identified by their location within the RT messages and by the class code of their content type. Once an information element is received and understood, a receiver is able to, for example, store the different RT+ information elements and the listener may then select and request a specific content type from the radio’s memory at an instant in time that suits the listener’s needs. Thus the listener is no longer forced to watch the RT information passing (scrolling) by. Moreover, RT+ offers selected RT message elements to car drivers on a static display, without risk of distracting the attention of the driver. Furthermore, RT+ is well suited for mobile phones with built-in FM receivers: telephone numbers can be directly used to initiate calls, and web addresses can be used to start browsing the web content offered by the radio programme provider. Last but not least, RT+ is also used for satellite radio broadcasting via DVB-S. It may be adopted by DRM and DAB in the future, too.

TA

Traffic Announcement: This is a temporary flag added to the RDS data stream only as a traffic bulletin is being aired. Some RDS car radios can be set to search for traffic bulletins among various TP stations (see TP below) while tuned to a listener’s preferred program, or even while playing a tape or CD. As soon as any TP station broadcasts a traffic bulletin, the receiver temporarily switches-over to receive it. When the bulletin is finished, the receiver switches back to the original program, tape or CD.

TDC

Transparent Data Channels: The transparent data channels consist of 32 channels, which may be used to send any type of data.

TMC

Traffic Message Channel: This feature is intended to be used for the coded transmission of traffic information.

TP

Traffic Program Identification: The TP flag identifies the station as one that routinely broadcasts traffic bulletins for motorists as part of its normal, everyday programming. When the TP flag is displayed on the receiver faceplate, the radio is searching for traffic announcements. The radio keeps track of TP stations offering this service to speed up the search-and-switch process.

PRODUCT REGISTRATION CARD

- All fields are required, or warranty registration is invalid and void

Your Company Name _____

Contact _____

Address Line 1 _____

Address Line 2 _____

City _____

State/Province _____ ZIP/Postal Code _____

Country _____

E-mail _____ Phone _____ Fax _____

Which DEVA Broadcast Ltd. product did you purchase? _____

Product Serial # _____

Purchase date ____ / ____ / ____

Installation date ____ / ____ / ____

Your signature*

*Signing this warranty registration form you are stating that all the information provided to DEVA Broadcast Ltd. are truth and correct. DEVA Broadcast Ltd. declines any responsibility for the provided information that could result in an immediate loss of warranty for the above specified product(s).

Privacy statement: DEVA Broadcast Ltd. will not share the personal information you provide on this card with any other parties.

WARRANTY TERMS AND CONDITIONS

I. TERMS OF SALE: DEVA Broadcast Ltd. products are sold with an understanding of “full satisfaction”; that is, full credit or refund will be issued for products sold as new if returned to the point of purchase within 30 days following their receipt, provided that they are returned complete and in an “as received” condition.

II. CONDITIONS OF WARRANTY: The following terms apply unless amended in writing by DEVA Broadcast Ltd.

A. The Warranty Registration Card supplied with this product must be completed and returned to DEVA Broadcast Ltd. within 10 days of delivery.

B. This Warranty applies only to products sold “as new.” It is extended only to the original end-user and may not be transferred or assigned without prior written approval by DEVA Broadcast Ltd.

C. This Warranty does not apply to damage caused by improper mains settings and/or power supply.

D. This Warranty does not apply to damage caused by misuse, abuse, accident or neglect. This Warranty is voided by unauthorized attempts at repair or modification, or if the serial identification label has been removed or altered.

III. TERMS OF WARRANTY: DEVA Broadcast Ltd. products are warranted to be free from defects in materials and workmanship.

A. Any discrepancies noted within TWO YEARS of the date of delivery will be repaired free of charge, or the equipment will be replaced with a new or remanufactured product at DEVA Broadcast Ltd. option.

B. Parts and labor for factory repair required after the two-year Warranty period will be billed at prevailing prices and rates.

IV. RETURNING GOODS FOR FACTORY REPAIR:

A. Equipment will not be accepted for Warranty or other repair without a Return Material Authorization (RMA) number issued by DEVA Broadcast Ltd. prior to its return. An RMA number may be obtained by calling the factory. The number should be prominently marked on the outside of the shipping carton.

B. Equipment must be shipped prepaid to DEVA Broadcast Ltd. Shipping charges will be reimbursed for valid Warranty claims. Damage sustained as a result of improper packing for return to the factory is not covered under terms of the Warranty and may occasion additional charges.